

Stress, inflammation, and reproduction



Stress, inflammation, and reproduction

VII Forum

3 July 2015, Siena

We would like to thank Dr. Claudia Tosti and Dr. Isabella Zanetti for the editorial support during the preparation of the manuscript.

© copyright 2015 by Percorsi Editoriali of Carocci Publisher, Rome

ISBN 978-88-430-8179-0

Printed in December 2015 by Eurolit, Rome

Cover by Falcinelli&Co. / Stefano Vittori
Graphic design by Ulderico Iorillo

Reproduction prohibited under the law
(Article 171 of the Law of 22 April 1941 no. 633)

Without proper authorization, you may not reproduce this volume even partially, by any means, including photocopying, even for internal or educational purpose.

Index

7 PRESENTATION
Silvia Misiti, Giuseppe Zizzo

9 INTRODUCTION
Felice Petraglia

SESSION 1 **STRESS**

13 STRESS AND EPIGENETICS
Marc Montminy

16 STRESS AND INFLAMMATION IN DISEASE
Nils Billestrup

21 ACTIVIN MEDIATORS AND MODULATORS
Pasquapina Ciarmela

SESSION 2 **STRESS AND INFLAMMATION**

33 GENETIC INSIGHTS ABOUT HOW THE BRAIN CONTROLS HUMAN REPRODUCTION: USE OF THE HUMAN DISEASE MODEL OF ISOLATED GONADOTROPIN-RELEASING HORMONE DEFICIENCY (IGD)
William F. Crowley

42 STRESS, INFLAMMATION, AND ENDOMETRIOSIS
Felice Petraglia

46 ACTIVINS: MORE THAN REPRODUCTIVE HORMONES
David de Kretser

53 NUCLEAR RECEPTORS AND “DIABESITY”: A ROADMAP TO HUMAN HEALTH

Ronald Evans

SESSION 3

STRESS, INFLAMMATION, AND REPRODUCTIVE MEDICINE

61 STRESS-INDUCED ANOVULATION: MIND OVER MATTER?

Sarah L. Berga

71 STRESS AND PCOS

Bart C.J.M. Fauser

76 STRESS, ENDOMETRIUM AND IMPLANTATION

Basil C. Tarlatzis, Antonis Kalpatsanidis, Antonis Makrigiannakis

83 STRESS AND INFERTILITY

Anthony Luciano

87 STRESS AND ART

Antonio Pellicer, Daniela Galliano

95 STRESS AND PRETERM BIRTH

John Challis

103 CONCLUSIONS

Presentation

Silvia Misiti

Head of IBSA Foundation for Scientific Research

Giuseppe Zizzo

Secretary of IBSA Foundation for Scientific Research

Stress has negative repercussions on the reproductive function. This is the clear conclusion emerging from the international Forum titled “Stress, Inflammation and Reproduction” organized by the IBSA Foundation for scientific research at the University of Siena, Italy. Evidence of this from fundamental and clinical research was presented by the various experts from the US, Australia and a number of European countries to the audience, including a copious number of students, who crowded the University Great Hall.

In his welcome address, opening the Forum, the Dean of the University of Siena, Angelo Riccaboni, underscored the importance of meetings like this for the entire academic community. Then, the Forum Chairman Professor Felice Petraglia, Chair of Obstetrics and Gynaecology, University of Siena and its Medical Centre, introduced the theme of the Forum, pointing out that stress affects psychological health and the immune system causing inflammation that, especially when chronic, interferes with the reproductive function, reducing the ability to conceive. Chronic psychological, metabolic or physical stress has a negative impact on the central nervous system and the hormonal system of both women and men, reducing their chances of conception. In 30% of couples who could not get pregnant, it has been found that high stress levels affected inflammatory cytokines and neuropeptides and inhibited ovulation and sperm production (B. C. Tarlatzis). The connection of the central nervous system, the endocrine system and the immune system is one of the newest pieces of evidence from modern research including in reproductive medicine (M. Montminy).

Professor Sarah Berga, Wake Forest Baptist Medical Center, USA, showed how amenorrhea in female athletes, significant weight loss and relationship crises involve a series of common factors and functions causing temporary infertility. Stress is a main cause of female reproductive diseases such as endometriosis which affects 10% of

women of reproductive age, and polycystic ovarian syndrome (PCOS) which affects 10-15% of women, as pointed out by Professor Bart Fauser, Utrecht University, the Netherlands. These disorders start from hormonal alterations and over time involve inflammatory mechanisms that reduce fertility. This is why recent treatments to combat infertility entail the use of hormones and anti-inflammatory medications. The conditions above are the most frequently diagnosed among those leading to assisted reproduction technology (ART) treatments at infertility centers (A. Luciano, A. Pellicer). 25% of couples undergoing ART treatment experience stress during the waiting period and in anticipation of results. This makes it more difficult to attain treatment success and often takes its toll on the couple relationship. Stress is dangerous during pregnancy too, as it can cause a miscarriage in the first months of pregnancy or premature births (J. Challis).

What can we do to fight stress, then? In his plenary lecture, Professor Ronald Evans, Director of the Salk Institute's Gene Expression Laboratory, La Jolla, California, USA – indicated as a candidate for the Nobel prize for medicine over the years – explained how modern pharmacology is working on novel molecules acting on stress mediators transcription and receptor mechanisms.

Introduction

Felice Petraglia

Department of Molecular and Developmental Medicine, Obstetrics and Gynaecology, University of Siena

The international Forum “Stress, Inflammation, and Reproduction” organized by IBSA Foundation for scientific research and hosted at the University of Siena on July 3, 2015 has been dedicated to the life and science of Wylie Vale.

He was really an incredible man, a biologist come from Houston, Texas. He was member of the faculty at the Salk Institute (La Jolla, CA). He was president of the American Endocrine Society and president of the International Society of Endocrinology. He was a member of the National Academy of Science and of the American Academy of Arts and Sciences as well as the Institute of Medicine. He published on great journals as “Nature”, “Science” and “Cell”. All his studies represent a perfect example of interdisciplinary: neuroendocrinology, stress, mood and behaviour, metabolism, reproduction and growth.

The key point of the meeting was: stress acts on both neuroendocrine function and immune system, and when become chronic it leads to a generalized inflammatory status. In particular, chronic inflammation interferes with reproductive functions, leading to an impairment of human fertility. Chronic stress – psychological, metabolic, or physical – exerts a negative influence on hormonal and neuro-psychological systems in both men and women, reducing the chance to conceive. High levels of stress have been found in about 30% of couples, which experience difficulties in achieving a pregnancy. These levels of stress may inhibit ovulation and spermatogenesis through the action of inflammatory cytokines and different kind of neuropeptides. The link between central nervous system and immune system is one of the most up-to-date evidences also in reproductive medicine.

Weight loss, athlete’s amenorrhea and emotional distress involve common mechanisms leading to temporary infertility. A major role of stress is also involved in the

pathogenesis of different gynecological diseases as endometriosis (affecting 10% of women of reproductive age) and polycystic ovary syndrome (affecting 10-15% of the same population). These diseases begin with hormonal alterations and subsequently involve inflammatory mechanisms leading to reduced fertility; for this reason, novel fertility treatments include both hormonal and anti-inflammatory preparations. In the Infertility Centers, the above-mentioned diseases are the most common diagnosis leading to the employment of assisted reproduction technologies. About 25% of couples undergoing these treatments also experience the stress of waiting time and expectation, further reducing the chance of success and often precipitating a crisis in the couple. Even when pregnancy is achieved, stress remains a potentially dangerous condition, as in the first months it may cause abortion, and later in gestation it may lead to preterm birth.

How is then possible to overcome stress? The modern pharmacology is working on new molecules acting on receptorial mechanisms and signal transcription of stress mediators.

SESSION 1

STRESS



Stress and epigenetics

Marc Montminy

Salk Institute, La Jolla, California, USA

The incidence of obesity (BMI ≥ 30) has risen to epidemic proportion). The reason why this is so important is that obesity is a major risk factor for the development of type II diabetes. Normally we keep in remarkable energy balance between the calories we take in and those we expend; this system is 99.9% efficient, but it is that 0.1% that gets us in trouble.

Insulin resistance leads to increases in circulating glucose concentrations. Normally glucose is kept in check by insulin; it promotes the down-regulation of hepatic glucose production when we feed and it also increases the flow of glucose into muscles. These two parameters are specifically affected in individuals with type II diabetes. When we fast, we break down glycogen for the first twelve hours or so and then we use gluconeogenesis to feed brain and the red blood cell compartment. The constitutive activation of gluconeogenesis accounts in part for the chronic hyperglycemia that is associated with type II diabetes.

In the fasting state, the downregulation of insulin stimulates the transcription factor FOXO1 while, in parallel, circulating glucagon increases the activity of CREB pathway.

The activation of CREB in response to cAMP is transient CREB activity reaches maximum levels after about 1 hour, decreasing thereafter even in presence of the hormone. CREB phosphorylation promotes an interaction with the histone acetyl transferase CBP. In addition, cAMP also triggers activation of the CRTCs (cAMP Regulated Transcriptional Coactivators) family of coactivators, which is composed by three members (CRTC1, CRTC2, CRTC3). They are also regulated by phosphorylation: under basal condition the CRTCs are sequestered in the cytoplasm, and upon stimulation with glucagon they undergo dephosphorylation, enter the nucleus, and bind with CBP to CREB. So there are two different events, both involving these accelerators and the proteins before mentioned. Like other cellular genes, the genes

that regulate gluconeogenesis are normally covered by histones. Increases in circulating glucagon promote histone acetylation over these genes, upregulating promoter activity. Hepatic CREB activity is increased in diabetes. Depletion of CRTC2 and CRTC3 lowers circulating glucose concentrations in insulin resistant mice. So the CRTC2 depleted mice are more insulin sensitive, suggesting that small molecule inhibitors of CRTC2 may be useful in the treatment of type II diabetes [1, 2].

In addition to its role in the liver during fasting, cAMP also shuts down the expression of cytokines genes activated in response to infection or high fat diet. The transcription factor NFkB is normally sequestered in the cytoplasm by another protein called IκB. During an infection, IκB undergoes degradation, leading to the nuclear translocation of p65. Following its association and acetylation by CBP, nuclear p65 upregulates the expression of cytokine genes.

Remarkably, we found that exposure to cAMP reduces p65 and histone H4 acetylation in LPS-stimulated macrophages: Indeed, exposure to Prostaglandin E2, which stimulates cAMP accumulation in macrophages, prevents p65 as well as histone acetylation over cytokine genes, down-regulating their expression.

We found that cAMP inhibits NF-κB activity by stimulating class IIa HDACs (Histone Deacetylases) (● Figure 1), which are regulated at the level of nuclear translocation. Under basal condition, HDAC4, the main class II HDAC in macrophages, is highly phosphorylated sequestered in the cytoplasm. Treatment with PGE2 stimulates the de-phosphorylation of HDAC4, allowing it to migrate into the nucleus where it inhibits NFκB activity. Mice with a knockout of the HDAC4 gene specifically in macrophages, have increased NFκB activity and cytokine gene expression relative to wild-type animals [3]. As a consequence, mice with a knockout of HDAC4 in macrophages have increased insulin resistance as well as circulating glucose and free fatty acid levels when placed on a high fat diet (● Figure 2).

● Figure 1. cAMP inhibits NF-κB activity by stimulating class IIa HDACs

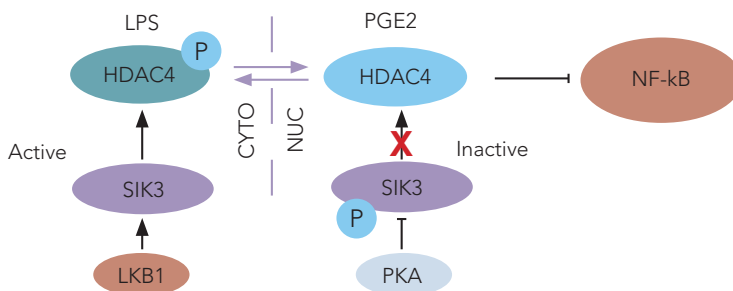

Source: Luan et al., 2014 [3].

• **Figure 2.** Increased insulin resistance in high fat diet-fed mice with a knockout of HDAC4 in macrophages

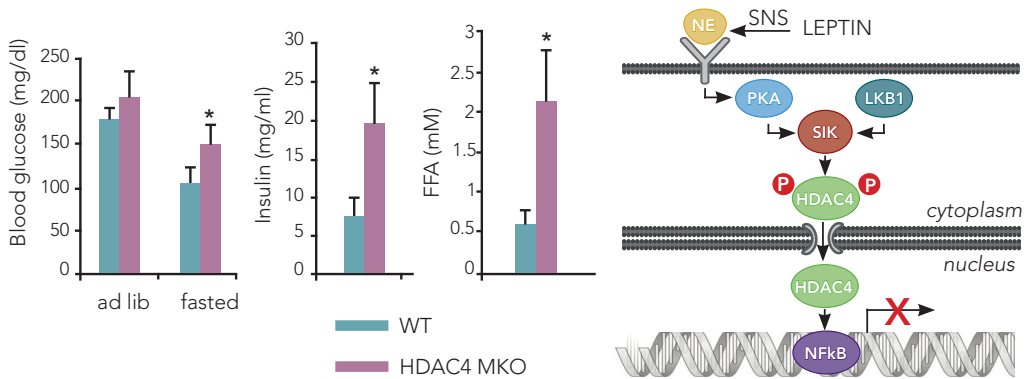

Source: Luan et al., 2014 [3].

Normally, in response to acute overfeeding, increases in circulating leptin stimulate norepinephrine production by the sympathetic nervous system, leading to the activation of a cAMP signaling cascade that promotes HDAC4 nuclear translocation and inactivation of NFκB activity in macrophages. When obesity is prolonged, however, the leptin-HDAC4 pathway is down-regulated, leading to increases in cytokine gene expression and insulin resistance. Future efforts to identify small molecules like rolipram, which restore class II HDAC activity in this setting, may provide therapeutic benefit to type II diabetic individuals.

References

- [1] Wang Y, Inoue H, Ravnskjaer K, Viste K, Miller N, Liu Y et al. Targeted disruption of the CREB coactivator *Crtc2* increases insulin sensitivity. *Proc Natl Acad Sci U S A* 2010 Feb 16;107(7):3087-92.
- [2] Oh KJ, Han HS, Kim MJ, Koo SH. *CREB and FoxO1: two transcription factors for the regulation of hepatic gluconeogenesis*. *BMB Rep* 2013;46(12):567-74.
- [3] Luan B, Goodarzi MO, Phillips NG, Guo X, Chen YD, Yao J et al. *Leptin-mediated increases in catecholamine signaling reduce adipose tissue inflammation via activation of macrophage HDAC4*. *Cell Metab* 2014;19(6):1058-65.

Stress and inflammation in disease

Nils Billestrup

University of Copenhagen, Denmark

Obesity is a global epidemic that takes place all over the world (• **Figure 1**). One of the major consequences of this is the increasing birth of diseases in global scale and this is associated to the relationship between obesity and low grade inflammation.

There are a number of hypotheses on the link between obesity and metabolic stress and inflammation: in the model showed in • **Figure 2**, a metabolically active cell, an adipocyte for example, upon an increased metabolic load, it will experience an activation of stress kinases and cytokines. If the stress becomes more pronounced, as in obesity, this activation become more prominent and more permanent. This results in activation of pro-inflammatory cytokines like $\text{TNF}\alpha$, $\text{IL-1}\beta$ and CCL2 that attract macrophages with modification in all the adipose tissue. If the metabolic load continues, the inflammatory state becomes chronic and the chemokines will attract immune cells into the metabolically active tissue [1].

We also know that one of the major effects of these pro-inflammatory cytokines, especially $\text{TNF}\alpha$, is actually to induce insulin resistance.

There is a very large number of diseases associated to chronic inflammation: many types of cancers, neurological diseases, pulmonary diseases, in particular also cardiovascular diseases, autoimmune diseases and of course metabolic diseases including type II diabetes.

Chronic inflammation role in type II diabetes

We know that there is an important genetic predisposition, but also environmental factors such as physical inactivity and obesity, that lead to a stage of impaired glucose tolerance with increasing insulin resistance and finally full blown diabetes. However we also know that a large part (2/3-3/4) of people that are very obese and insulin

• **Figure 1.** Map of global obesity* ages +18 (female, 2014)

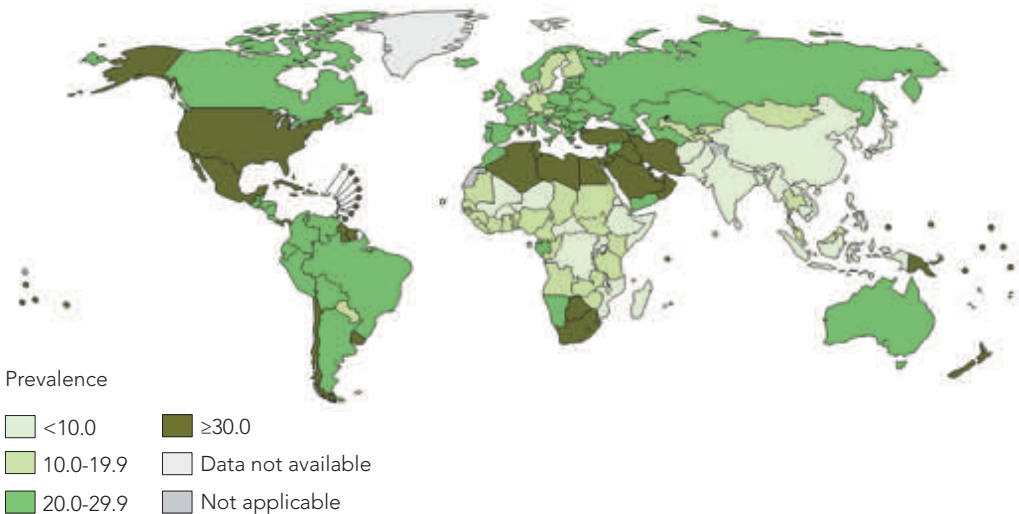

*Body Mass Index ≥ 30 kg/m².

Source: WHO, 2015.

resistant do not develop type II diabetes and that is due to the ability of beta cells to compensate insulin resistance. In a condition of impaired glucose tolerance, there is a loss of the first phase insulin release, that eventually leads to severe beta cell failure and finally beta cell loss leading to full blown diabetes [2]. Diabetes is a beta cell disease: an insufficient beta cell mass causes diabetes.

If we look at the regulation of the pancreatic beta cell mass, there is of course neo-formation as seen during beta cell development and transdifferentiation (transformation of a pancreatic glucagon secreting alpha-cell into a beta cell), a very interesting mechanism to study for future treatments. We also know that beta cells can divide by mitosis and there are growth factors that act on these cells, like PRL, GLP-1, CRF, Ucn3. Beta cells death is of course important for diabetes, and there ongoing studies about prevention of apoptosis and necrosis by inhibiting pro-apoptotic inflammatory cytokines. Beta cell can be lost also by a mechanism called dedifferentiation or impaired beta cell function.

There is evidence that Activin and BMPs (Bone Morphogenetic Proteins) are dys-regulated in various stages of insulin resistance: they all bind to receptors and activate intracellular transcriptional factors such as Smad1, Smad2 and Smad3, which become phosphorylated and stimulate expression of target genes [3].

• **Figure 2.** Link between obesity and metabolic stress and inflammation

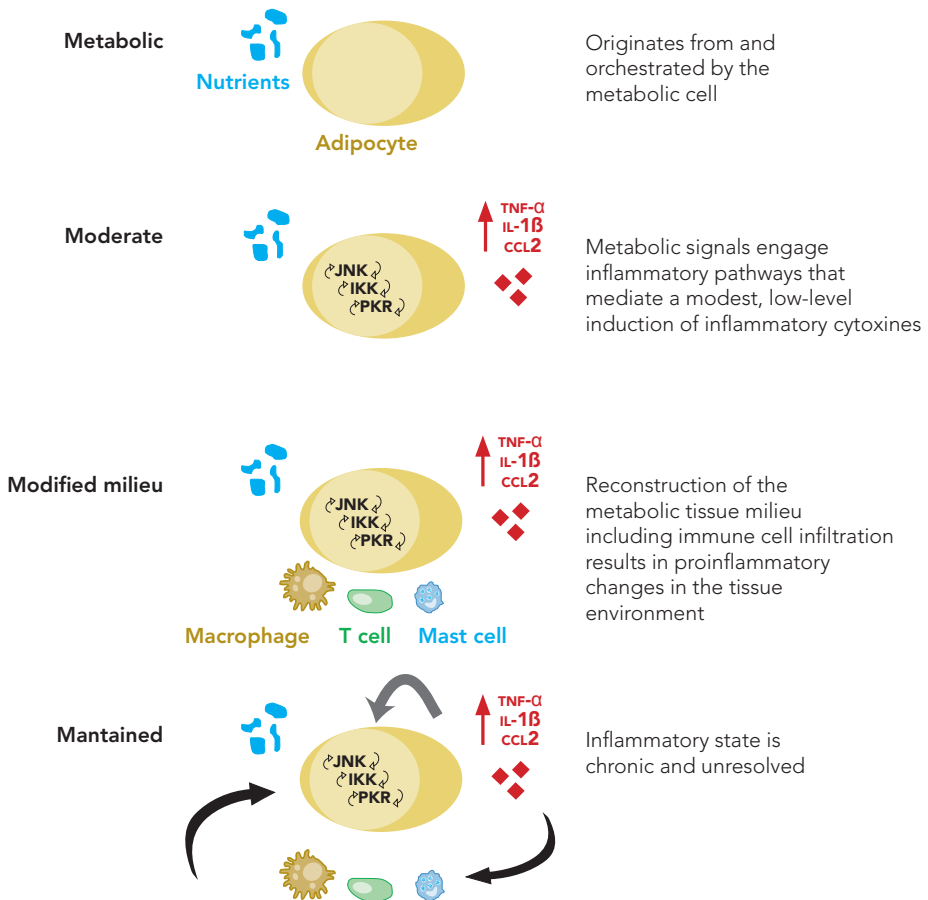

Source: Gregor, Hotamisligil, 2011 [1].

A possible role of BMP2 in the development of beta cell dysfunction in type 2 diabetes was recently suggested. This was further supported by a new interesting Swedish study on pancreatic islets collected from 89 organ donors, including donors with diabetes, on which was demonstrated that expression of BMP2 mRNA was positively and significantly correlated with HbA1c [4].

Regarding the biological action of the BMP on the pancreatic islets, it has been seen in mice that BMP is a potent inhibitor of beta cell proliferation and upregulated by cytokines. That could fit with the idea that it is implicated as a mediator in poor function beta cells in response to inflammation.

If we neutralize the BMP produced by beta cells using a molecule formed by extra-cellular domain of the BMP receptor fused to the Fc part of IgG specific for ALK-3 (a specific receptor for BMP), we found increased insulin release from human islets, while addition of BMP would inhibit the release of insulin.

But what about cytokines involvement? It has been demonstrated that IL-1 β induces beta cell dysfunction and that can be neutralized by BMP neutralizing agents indicating a role of BMP in mediating the effects of IL-1 β .

Glucose is recognized and metabolized by the beta cell and translated into a calcium response that stimulates the fusion of the insulin granules with the cell membrane leading to the release of insulin. If a cell is stimulated with BMP, exocytosis is reduced, calcium channels activity is reduced and consequently also insulin secretion. We don't know yet which genes are responsible for that, but in • **Table 1** are reported some of the main selected genes probably involved.

In conclusion, metabolic stress, free fatty acids, high glucose, reactive oxygen species, inflammation, in particular cytokines, affect the expression of certain genes like BMP2, which can be neutralized by fusion proteins. If BMP2 is allowed to work it can regulate the transcription of many genes that are important for beta cell identity, influencing insulin secretion and beta cell proliferation to compensate the insulin resistance.

• **Table 1.** Selected genes regulated by BMP in islets

Name	Regulation	Fold	P
SMAD 7	up	55.9	1.569E-05
SMAD 9	up	11.3	9.189E-07
BAMBI	up	3.9	1.681E-06
ID-1	up	14.9	1,387E-05
ID-2	up	4.3	4,132E-05
ID-3	up	17.6	5,629E-06
HES-1	up	3.8	2.493E-03
HEY	up	4.2	2.782E-03
GPR6	down	3.3	3.468E-06

ID: Inhibitor of DNA binding/differentiation.

HES-1: Hairy/enhancer of split-1.

HEY: Hairy/enhancer of split-related with YRPW motif protein 1.

Source: Christensen *et al.*, 2015 [5].

References

- [1] Gregor MF, Hotamisligil GS. *Inflammatory mechanisms in obesity*. Annu Rev Immunol 2011;29:415-45.
- [2] Leahy JL. *β -Cell dysfunction in type 2 diabetes mellitus*. In Kahn CR, Weir GC, King GL, Jacobson AM, Moses AL, Smith RJ, Eds. *Joslin's Diabetes Mellitus*. 14th ed. Philadelphia, Lippincott, Williams & Wilkins, 2005.
- [3] Bruun C, Christensen GL, Jacobsen MLB, Kanstrup MB, Jensen PR, Fjordvang H *et al*. *Inhibition of beta cell growth and function by bone morphogenic proteins*. Diabetologia 2014;57:2546-54.
- [4] Fadista J, Vikman P, Laakso EO, Mollet IG, Esguerra JL, Taneera J *et al*. *Global genomic and transcriptomic analysis of human pancreatic islets reveals novel genes influencing glucose metabolism*. Proc Natl Acad Sci U S A. 2014 Sep 23;111(38):13924-9.
- [5] Christensen GL, Jacobsen MLB, Wendt A, Mollet IG, Friberg J, Frederiksen KS *et al*. *Bone morphogenetic protein 4 inhibits insulin secretion from rodent beta cells through regulation of calbindin1 expression and reduced voltage-dependent calcium currents*. Diabetologia 2015;58:1282-90.

Activin mediators and modulators

Pasquapina Ciarmela

Department of Experimental and Clinical Medicine, Polytechnic University of Marche, Ancona, Italy

Activins and inhibins are proteins belonging to the family of TGF β . These proteins are dimers formed by two subunits, in particular activin is an homodimer composed by two β subunits and inhibin is a heterodimer formed by an α subunit and a β subunit. Activin A is composed by two β A subunits, activin AB by a β A and a β B, and activin B by two β B subunits. If the β subunit in inhibin is type A, then the protein will be inhibin A and if the β subunit is type B, it will be called inhibin B. Activin A is the most common and most studied.

The names of these two proteins come from their ability to respectively activate or inhibit the FSH production by the anterior pituitary gland and their interaction with the hypothalamic-pituitary-ovarian axis.

In 1986 Wylie Vale described the purification of an FSH releasing protein, produced in the ovarian follicular fluid and composed of two inhibin β A subunits.

What is the molecular mechanism of activin action? Activin has two receptors: ActRII and ActRI (ALK-4). Through crosslink experiments, in which iodinated activin is irreversibly bound to its binding partners on the cells surface, it had been shown that activin is associated with two cell surface proteins designed type I and type II. Activin in the extracellular space is able to bind ActRII or ActRIIB with its consequent phosphorylation. Only after this complex has been formed, the type II receptor is able to bind ActRI and phosphorylate it and then the signal can be translocated into the cytoplasmatic space throughout the phosphorylation of the Smad proteins type 2 and 3. Phosphorylated Smad2 and Smad3 mediate transcriptional activation of activin target genes in the nucleus, binding to other cofactors.

The situation is actually more complex because there are other players like Smad7, an inhibitor Smad that blocks phosphorylation of Smad2 and 3, thereby providing a short-loop negative feedback regulation for this signaling pathway. Activin signal-

ing is regulated also by several extracellular factors, including the receptor antagonist inhibin and the activin binding protein follistatin, both of which antagonize activin actions [1]. The follistatin family binds ligands in the extracellular space, preventing the binding of activin to ActRIIs. Thus, the initial steps of signal transduction are inhibited by members of the follistatin family.

Another molecule recently discovered among the ones that inhibit activin signal is Cripto. This protein antagonizes activin signaling by forming a complex with activin and ActRII/IIB. This complex seems to preclude the formation of a functional activin-ActRII/IIB-ALK4 complex and therefore blocks signaling [2].

Activin is involved in a wide range of biological systems and functions including reproductive tissues. The actions of activin in the endometrium are well-established, while activin expression and activin actions in the myometrium are less clear.

Myometrium is the smooth muscle layer of the uterus and its cells can proliferate enormously, especially during pregnancy. To see whether myometrial is responsive to activating A, we first tested if rat uterus explants exhibit detectable Smad signaling after activin A treatment. As shown in • **Figure 1**, activin A induces phosphorylation of Smad 2 in rat uterus explants (A, upper panel), and in two different myometrial cell lines, hTERT HM (B, upper panel) and PHM1 (C, upper panel). The levels of Smad 2 and 3, showed in the lower panels, instead resulted unchanged. In C is shown the complete abrogation of the signal by follistatin co-treatment [3].

We also investigated whether activin A could regulate myometrial cell growth. Cell proliferation is measured using the CyQuant cell proliferation assay kit. In • **Figure 2** we can see the changes in PHM1 number in cells seeded in a 96-well plate at a density of 1000 cells at different days with (A) or without (NT) activin A treatment. Activin A treated cells decreased cell numbers compared to the untreated ones, demonstrating that activin A could inhibit PHM1 growth [3].

A major women's health problem are uterine fibroids, or leiomyomas. They are the most common pelvic tumour occurring in 20-30% of fertile women and presenting clinical complications that seriously impact women's health. Uterine fibroid can vary in size, even be giant, be single or multiple up to huge number. They can affect women with prolonged menstrual bleeding and consequent anemia, pain in the back of the legs, pelvic pain or pressure, infertility, and recurrent pregnancy loss. The impact on women's life is serious, in fact a recent American survey on 1000 employers reported that almost a third of employers (28%) miss work due to leiomyoma symptoms and 24% of women believe that their symptoms prevented them from reaching their career potential [4]. Therefore, live with fibroids is a heavy source of stress and psychological and moral damage. In addition, women expressed desire for treatments that do not involve invasive surgery (79%), preserve the uterus (51%), and preserve fertility (43% of women aged <40 years) [4].

To understand this disease it must be considered the role of genetics, extracellular matrix (ECM), and hormones in tumor etiology. In a ten years ago review, it was described

● **Figure 1.** Myometrial responsiveness to activin A

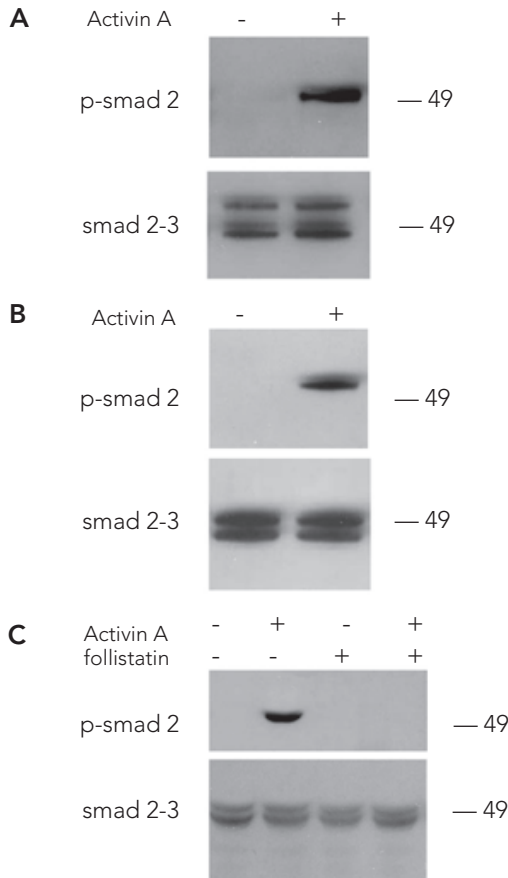

Source: Ciarmela *et al.*, 2008 [3].

the etiology of uterine fibroids by cell proliferation and extracellular matrix production and its promotion by both endocrine and autocrine growth factors (● **Figure 3**) [5]. Among the growth factors, activin A mRNA is higher expressed in fibroid specimens compared to adjacent myometrium, as shown in our study published in 2011 [6].

Activin A exerts its biological effects on different cell types usually through Smad signaling pathway, but it can also activate non-Smad signaling pathways such as p38MAPK and ERK [7]. We tested which signaling is activated in myometrial and leiomyoma cells and we show that activin A is able to activate Smad 2 and 3, while had no effect on p38MAPK and ERK signaling [8].

● **Figure 2.** Effect of activin A on PHM1 myometrial cell proliferation

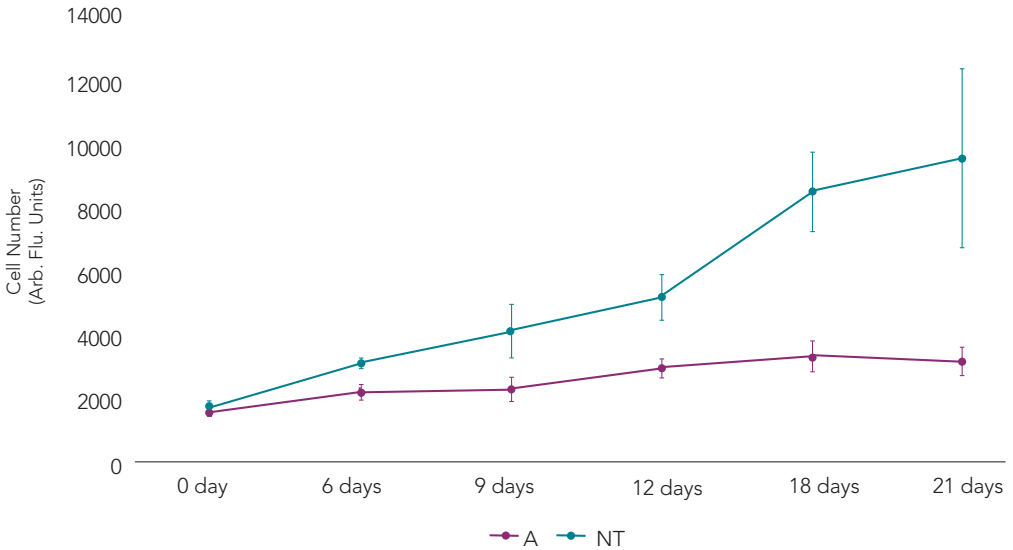

Changes in PHM1 number in cells seeded in a 96-well plate at a density of 1000 cells at different days. A, with activin A treatment; NT, without treatment.

Source: Ciarmela *et al.*, 2008 [3], modified.

● **Figure 3.** Etiology of the uterine fibroids

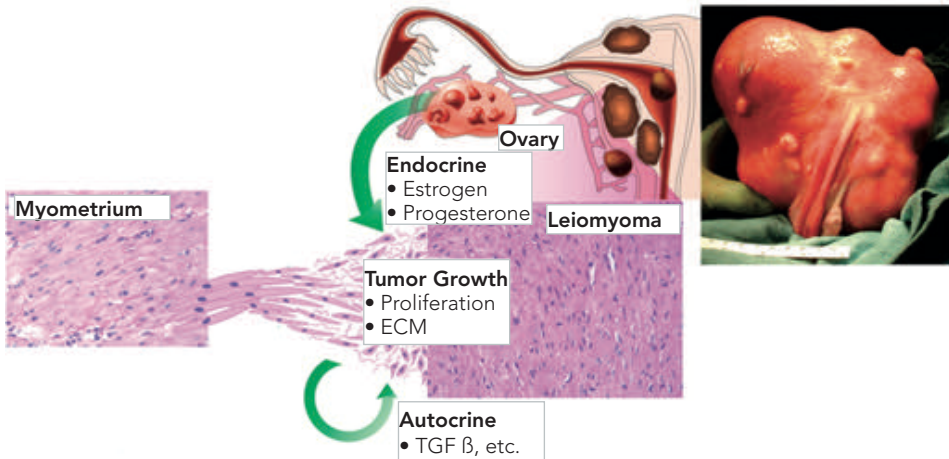

Source: Walker, Stewart, 2005 [5], modified.

Considering the fact that leiomyomas development and growth depend on cell proliferation, fibrosis, angiogenesis and inflammation, we went to study the effect of activin A on these aspects. Using three different approaches (cell proliferation assay, detection of PCNA and Ki-67), we saw that activin was able to suppress the proliferation in primary myometrial cells, but when we looked at the leiomyomas cells we were surprised to discover that activin had no effect on them.

The ECM synthesis is an important event in leiomyoma growth. Recent studies suggest that alterations in ECM can modify mechanical stress on cells, which leads to activation of internal mechanical signaling contributing to leiomyoma. Primarily collagens, fibronectin, and proteoglycans have been found in leiomyoma with altered expression compared with normal myometrium. We checked the fibronectin expression with real-time PCR, western blotting and immunocytochemistry, and we found that activin A increases it in leiomyoma cells. We went to see also other two important proteins of ECM, collagen 1A1 and versican: real-time PCR showed that in leiomyomas cells activin is able to increase them.

In conclusion, activin, in myometrial cells is able to block cell proliferation and has no effect on ECM proteins, while in leiomyomas cells it does not affect the cell proliferation and contrarily promote ECM protein apposition [8].

Angiogenic growth factors play an important role in mechanisms of fibroid pathophysiology, including abnormal vasculature and fibroid growth and survival. Moreover, the fibroid's abnormal vasculature and its aberrant hypoxic and angiogenic response may make it especially vulnerable to disruption of its vascular supply, a feature which could be exploited for treatment [9].

Genetic aberrations involving genes such as HMGA2 (high-mobility group AT-hook 2 protein), MED12 (mediator subunit complex 12) and FH (fumarate hydratase) may initiate unregulated cell proliferation of myometrial stem cells. Cyclic menstrual contractions of the myometrium result in periodic hypoxia/ischemia, which may lead to differentiation of myometrial stem cells into SMCs (smooth-muscle cells). Continued uncontrolled proliferation of mutated stem cell derived SMCs would result in foci of myometrial hyperplasia. The effects of gonadal steroids in combination with the chronic hypoxia associated with the rapidly expanding myometrial hyperplasia cell mass would stimulate local angiogenic growth factor expression. These, in turn, would promote continued cell proliferation, and ECM deposition, and provide a vascular support to the growing myometrial cell mass, resulting in leiomyoma formation [9]. Interestingly, we found that activin A induces VEGF mRNA expression in myometrial and leiomyoma cells [10].

Inflammatory mediators has been reported to be higher expressed in leiomyoma tissues. We have recently found higher numbers of macrophages inside and in the vicinity of leiomyoma as compared to the more distant surrounding myometrium. In addition, activin A mRNA is increased by TNF- α in myometrial and leiomyoma cells (unpublished data). In conclusion, activin A may offer a mechanistic explanation

• **Figure 4.** Leiomyoma development

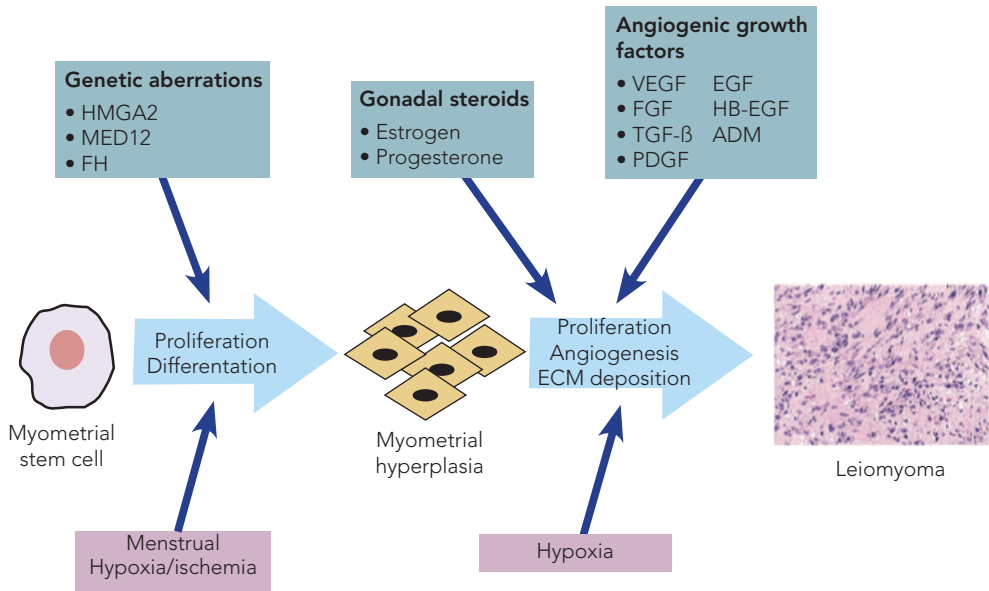

Source: Tal et al., 2014 [9].

for the progression of leiomyomas, and it may be potential therapeutic or preventive targets for uterine fibroids.

Finally, I would like to report therapeutic compounds (synthetic and natural) for uterine fibroid treatment: genistein, tranilast, ulipristal acetate (UPA) and how those can modulate activin A in leiomyoma cells.

Genistein (5,7-Dihydroxy-3-(4-hydroxyphenyl)chromen-4-one) is an isoflavone found in soybeans (*Glycine max*), lupine (*Lupinus* spp.), fava bean (*Vicia faba*). It has been shown *in vivo* to be beneficial in the prevention of a wide variety of chronic diseases, including cancer [11]. It was reported that high doses of genistein ($\geq 10 \mu\text{g/ml}$) had an inhibitory effect on uterine leiomyoma cells [12]. Furthermore, it has been described that dietary supplementation of genistein reduces the incidence and size of spontaneously occurring leiomyoma of the oviduct in the Japanese quail [13]. Interestingly, it has been found that activin a down regulates activin A and Smad 3 expression in leiomyoma cells [14].

Tranilast (N-[3, 4-dimethoxycinnamoyl] anthranilic acid) is a synthetic drug of low toxicity that has been widely used clinically in Japan since the 1980s [15]. It is effective in diseases associated with excessive fibrosis such as keloid tumors (a fibrotic disorder that shares similar molecular and epidemiologic features with leiomyomas). Tranilast can regulate cell proliferation and fibrosis in various cancers and tumors cell

lines. Shime *et al.*, and recently our group, confirmed the antiproliferative effect of tranilast on leiomyoma cells [16, 17]. In addition, we also found that tranilast decreases the expression of fibronectin, collagen 1A1, versican, as well as activin A in myometrial and leiomyoma cells [18].

UPA (17 α -acetoxy-11b-[4-N,N-dimethylaminophenyl]-19-norpregna-4,9-diene-3,20-dione) or CDB-2914, is an SPRM that binds to progesterone receptors A and B with high affinity [19]. Phase III clinical trials have shown that CDB-2914 is effective for the reduction of uterine bleeding, fibroid volume, and improve quality of life, without the side effects associated with other medications such as gonadotropin-releasing hormone (GnRH) agonist [20]. On 2012, UPA (5mg) was approved by European Medicines Agency (EMA) for the treatment of moderate to severe symptoms-limited to 3 months and pre-surgery. Interestingly, we found that activin A, follistatin and ActRIIB expression levels are decreased by UPA in leiomyoma cells [10].

References

- [1] Lewis KA, Gray PC, Blount AL, MacConell LA, Wiater E, Bilezikjian LM, Vale W. *Betaglycan binds inhibin and can mediate functional antagonism of activin signalling*. Nature 2000 Mar 23;404(6776):411-4.
- [2] Gray PC, Harrison CA, Vale W. *Cripto forms a complex with activin and type II activin receptors and can block activin signaling*. Proc Natl Acad Sci U S A 2003 Apr 29;100(9):5193-8.
- [3] Ciarmela P, Wiater E, Vale W. *Activin-A in myometrium: characterization of the actions on myometrial cells*. Endocrinology 2008 May;149(5):2506-16.
- [4] Borah BJ, Nicholson WK, Bradley L, Stewart EA. *The impact of uterine leiomyomas: a national survey of affected women*. Am J Obstet Gynecol 2013 Oct;209(4):319.e1-319.e20.
- [5] Walker CL, Stewart EA. *Uterine fibroids: the elephant in the room*. Science 2005 Jun 10;308(5728):1589-92.
- [6] Ciarmela P, Bloise E, Gray PC, Carrarelli P, Islam MS, De Pascalis F *et al*. *Activin-A and myostatin response and steroid regulation in human myometrium: disruption of their signalling in uterine fibroid*. J Clin Endocrinol Metab 2011 Mar;96(3):755-65.
- [7] Derynck R, Zhang YE. *Smad-dependent and Smad-independent pathways in TGF-beta family signalling*. Nature 2003 Oct 9;425(6958):577-84.

- [8] Islam MS, Catherino WH, Protic O, Janjusevic M, Gray PC, Giannubilo SR *et al.* *Role of activin-A and myostatin and their signaling pathway in human myometrial and leiomyoma cell function.* J Clin Endocrinol Metab 2014 May;99(5):E775-85.
- [9] Tal R, Segars JH. *The role of angiogenic factors in fibroid pathogenesis: potential implications for future therapy.* Hum Reprod Update 2014 Mar-Apr;20(2):194-216.
- [10] Ciarmela P, Carrarelli P, Islam MS, Janjusevic M, Zupi E, Tosti C *et al.* *Ulipristal acetate modulates the expression and functions of activin a in leiomyoma cells.* Reprod Sci 2014 Sep;21(9):1120-5.
- [11] Gupta SC, Kim JH, Prasad S, Aggarwal BB. *Regulation of survival, proliferation, invasion, angiogenesis, and metastasis of tumor cells through modulation of inflammatory pathways by nutraceuticals.* Cancer Metastasis Rev 2010 Sep;29(3):405-34.
- [12] Moore AB, Castro L, Yu L, Zheng X, Di X, Sifre MI *et al.* *Stimulatory and inhibitory effects of genistein on human uterine leiomyoma cell proliferation are influenced by the concentration.* Hum Reprod 2007;22:2623-31.
- [13] Sahin K, Akdemir F, Tuzcu M., Sahin N, Onderci M, Ozercan R *et al.* *Genistein suppresses spontaneous oviduct tumorigenesis in Quail.* Nutr Cancer 2009;61:799-806.
- [14] Di X, Andrews DM, Tucker CJ, Yu L, Moore AB, Zheng X *et al.* *A high concentration of genistein down-regulates activin A, Smad3 and other TGF- β pathway genes in human uterine leiomyoma cells.* Exp Mol Med 2012 Apr 30;44(4):281-92.
- [15] Azuma H, Banno K, Yoshimura T. *Pharmacological properties of N-(3',4'-dimethoxycinnamoyl) anthranilic acid (N-5'), a new anti-atopic agent.* Br J Pharmacol 1976;58:483-8.
- [16] Shime H, Kariya M, Orii A, Momma C, Kanamori T, Fukuhara K *et al.* *Tranilast inhibits the proliferation of uterine leiomyoma cells in vitro through G1 arrest associated with the induction of p21waf1 and p53.* J Clin Endocrinol Metab 2002 Dec;87(12):5610-7.
- [17] Islam MS, Protic O, Giannubilo S, Stortoni P, Ciavattini A, Lamanna P *et al.* *Anti-proliferative effect of tranilast on human myometrial and leiomyoma cells.* Biol Biomed Rep 2012;2:321-7.
- [18] Islam MS, Protic O, Ciavattini A, Giannubilo SR, Tranquilli AL, Catherino WH *et al.* *Tranilast, an orally active anti-allergic compound, inhibits extracellular matrix production in human uterine leiomyoma and myometrial cells.* Fertil Steril 2014 Aug;102(2):597-606.

[19] Attardi BJ, Burgenson J, Hild SA, Reel JR, Blye RP. *CDB-4124 and its putative monodemethylated metabolite, CDB-4453, are potent antiprogestins with reduced antiglucocorticoid activity: in vitro comparison to mifepristone and CDB-2914.* Mol Cell Endocrinol 2002 Feb 25;188(1-2):111-23.

[20] Donnez J, Tatarchuk TF, Bouchard P, Puscasiu L, Zakharenko NF, Ivanova T *et al.* *Ulipristal acetate versus placebo for fibroid treatment before surgery.* N Engl J Med 2012 Feb 2;366(5):409-20.

SESSION 2

STRESS AND INFLAMMATION

Genetic insights about how the brain controls human reproduction: use of the human disease model of isolated gonadotropin-releasing hormone deficiency (IGD)

William F. Crowley, Jr.

Daniel K. Podolsky Professor of Medicine, Harvard Medical School, Harvard National Center of Excellence in Translational Research in Fertility and Infertility, The Reproductive Endocrine Unit of the Department of Medicine, Boston, USA

The hierarchy of the Hypothalamic-Pituitary-Gonadal axis is outlined in • **Figure 1**. Collectively, its activity is initiated by the secretion of Gonadotropin Releasing Hormone (GnRH) from the hypothalamus that, in turn, directs the anterior pituitary gland's gonadotropes to release Luteinizing Hormone (LH) and Follicle Stimulating Hormone (FSH). Together these gonadotropins stimulate the 2 key activities of the gonads, i.e. steroidogenesis and gametogenesis. This hierarchy is identical whether an ovary or a testis is at the end of this complex regulatory system whose forward feedback by GnRH and gonadotropins are then restrained by the negative feedback of sex steroids (testosterone, estradiol, and progesterone) and gonadal peptides (Inhibin A & B and activin).

While GnRH has been traditionally viewed as the prime activator of the normal Hypothalamic-Pituitary-Gonadal axis, there are daunting methodological problems to its study in humans (• **Figure 1**). There are only ~1,200 GnRH neurons in the human brain. In addition to their small numbers, they are also quite small in size and widely dispersed neuroanatomically, typical of hypothalamic neural networks. GnRH cannot be directly measured in the circulation due to its short half life ($T_{1/2}$ of 2-4 minutes) and the restriction of its secretion to the hypophyseal-portal blood supply. Consequently, to obtain information about GnRH secretory activity in humans, it has been necessary to monitor the pulsatile pattern of LH and Free Alpha Subunit release via frequent sampling (every 10 minutes) from the anterior pituitary to infer the frequency of antecedent bursts of GnRH secretion from their upstream hypothalamic GnRH neurons. Last but not least, to obtain a robust sense of GnRH's physiology, clinical research must be done in children and adults of both sexes where there are further obstacles to human studies.

Given these impressive research constraints, a consensus has emerged that GnRH and

its upstream secretagogue, kisspeptin, act together as the twin “pilot lights of reproduction” governing the activity of the mammalian reproductive axis. More importantly, the integrity of this reproductive system is critical not only for the reproductive health of the individual but also for the evolution of the species as its secretory activity ultimately determines the reproductive “fitness” of any species. This daunting mandate is achieved by modulating the internal reproductive endocrine responses to various changing and challenging external environments such as the body’s responses to swings in nutrition, exercise, olfaction, and predator density. Furthermore, if one thinks about the “big three” biological mandates to the hypothalamus, the GHRH/GRP/GH axis oversees growth, development, and nourishment; the CRF axis deals with stress; and the GnRH axis fulfils both the individual and species’ mandate to reproduce.

However, since the decoding of the human genome in the mid-1990s, a striking paradox emerged in human reproduction. GnRH, the central controller of reproduction, was discovered to be one of the few genes lacking any genetic redundancy in our genome. Unlike transcription factors, GPCRS, their second messengers, and several categories of protein families, GnRH apparently lacks any biological redundancy. This genetic singularity was not only quite surprising but discordant with the known

• **Figure 1.** Normal HPG Axis

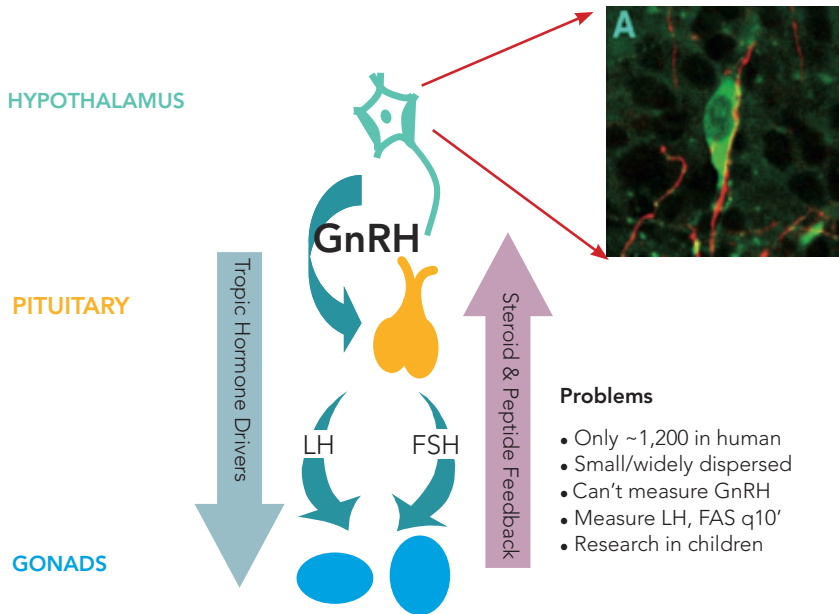

Organization of the hypothalamic-pituitary-gonadal axis with associated difficulties involved in its study in humans.

clinical and genetic heterogeneity of the syndromes associated with IGD as well as the complex development agenda underlying the ontogeny of the GnRH neurons. Consequently, on the basis of these startling genetic findings, beginning in 1996 we began to redirect our entire research program towards understanding the “upstream genes” that must exist and be required to explain this genetic singularity and its clinical discrepancy and thus must regulate GnRH secretion.

To put this problem in an even longer historical perspectives, in 1943 Fuller Albright, arguably the father of modern endocrinology, was visited a 28 year man because of a constellation of symptoms including a complete absence of puberty; a small phallus; tiny and undescended testes; complete anosmia; and low levels of urinary gonadotropins (• **Figure 2**). His negative skull film suggested no anatomic cause for these abnormalities. By that late stage of his career, Albright’s advanced Parkinson’s disease prohibited him from writing legibly in the chart. Consequently, a series of endocrine fellows were assigned to accompany him to transcribe his thoughts in writ-

• **Figure 2.** Isolated GnRH deficiency

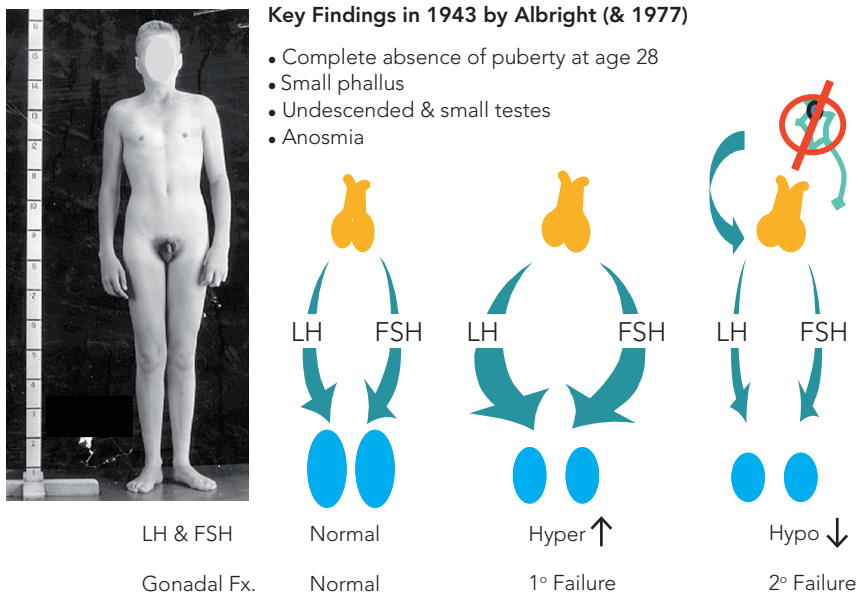

The first case of Kallmann Syndrome seen by Fuller Albright and colleagues in 1943 in the Endocrine Clinic of the Massachusetts General Hospital studied with urinary gonadotropin assays to determine their hypogonadotropic state. The panel on the right indicates the hypothesis that the defect resides in the hypothalamus vs the anterior pituitary gland as subsequently proven in • **Figure 3**.

ing when seeing patients. The two fellows seeing this patient with him, Drs. Harry Klinefelter and Fred Reifstein, recorded that Albright presciently commented: “We should employ the new urinary gonadotropin assays in this man as the ‘measuring sticks’ of pituitary gonadotropin output that could help determine the level of his defect, i.e. whether pituitary or gonadal”. Since this patient did not have a pituitary tumor, had exhibited normal growth, and had normal thyroid testing but with low gonadotropin levels, Albright’s team assigned him the diagnosis of Isolated Gonadotropin Deficiency (IGD), implying he suffered from a pituitary defect. I first saw this patient in 1977 in our Endocrine Clinic at the Massachusetts General Hospital, 6 years following the Nobel discovery of GnRH in 1971. Consequently, my hypothesis was that perhaps his defect was not at the level of gonadotropin secretion at the anterior pituitary but rather that he might harbour a hypothalamic defect in the secretion or action of GnRH. Of course, GnRH testing was required to distinguish these two possibilities which we did and the results of this experiment forever changed the name of this syndrome to Isolated GnRH Deficiency (IGD).

In 1980, we demonstrated that the chronic administration of small doses of exogenous GnRH, delivered at 2-hourly intervals designed to mimic the normal frequency of endogenous GnRH secretion we had previously documented to occur in normal males [1], to men with the Kallmann Syndrome variant of IGD like this patient. This regimen completely reconstituted a physiologic pattern of pulsatile LH secretion, normalized their serum testosterone, LH and FSH levels, restored their spermatogenesis, and thus produced a complete normalization of their reproductive axes (• **Figure 3**). Similar results occurred in women where ovulation could be induced by an appropriately fashioned pulsatile GnRH regimen [2].

Simultaneously, investigators at the Rockefeller Institute posed a simple question about the source of GnRH neurons: “Where do the hypothalamic GnRH neurons originate embryologically?”. Using simple immunocytochemical staining for GnRH, they were astonished to discover that the GnRH precursor neurons, as distinct from all other known hypothalamic neurons, in fact, did not originate from within the CNS [3]. Rather, the embryonic origins of GnRH neurons were extramural to the brain, having been derived from the embryonic olfactory placode where they begin to differentiate into GnRH neurons on embryonic Days 10.5-11. Thereafter, they migrate out of the olfactory placode, cross the cribriform plate, and penetrate into the CNS by following the olfactory tracts by ED 14. By ED 16, these new GnRH neurons had taken up permanent residence within the arcuate nucleus of the medial basal hypothalamus. During their embryonic migration, the GnRH neurons become more differentiated and mature by acquiring the capability of secreting GnRH and relinquishing their migratory capabilities. In 1989, these investigators had access to the brain of a male human fetus who had an ensemble of genetic syndromes including Kallmann syndrome, ichthyosis, and chondrodysplasia punctata [4]. As opposed to the brief neonatal “minipuberty” that normally occurs during the neonatal period

when GnRH induces secretion of gonadotropins and gonadal steroids in the weeks following birth, this Kallman Syndrome child's gonadotropins and serum testosterone levels remained low. At autopsy, he had a complete lack of olfactory bulbs and tracts in addition to microphallus and cryptorchidism, thus confirming the diagnosis of Kallmann syndrome, a variant of IGD. The fetus and his mother shared a terminal deletion of the Xp22.31 chromosome that ultimately assisted in the localization of the *KAL1* gene to the X gene [4].

Overall, Isolated GnRH Deficiency (IGD) is a rare mendelian disorder with the incidence of Kallman Syndrome being 1:30,000 in males and 1:120,000 in females in a well-surveyed Icelandic population [5]. From the >2,000 MGH cases we have collected

• **Figure 3.** Pulsatile GnRH Rx: re-constitutes normal HPG axis in IHH

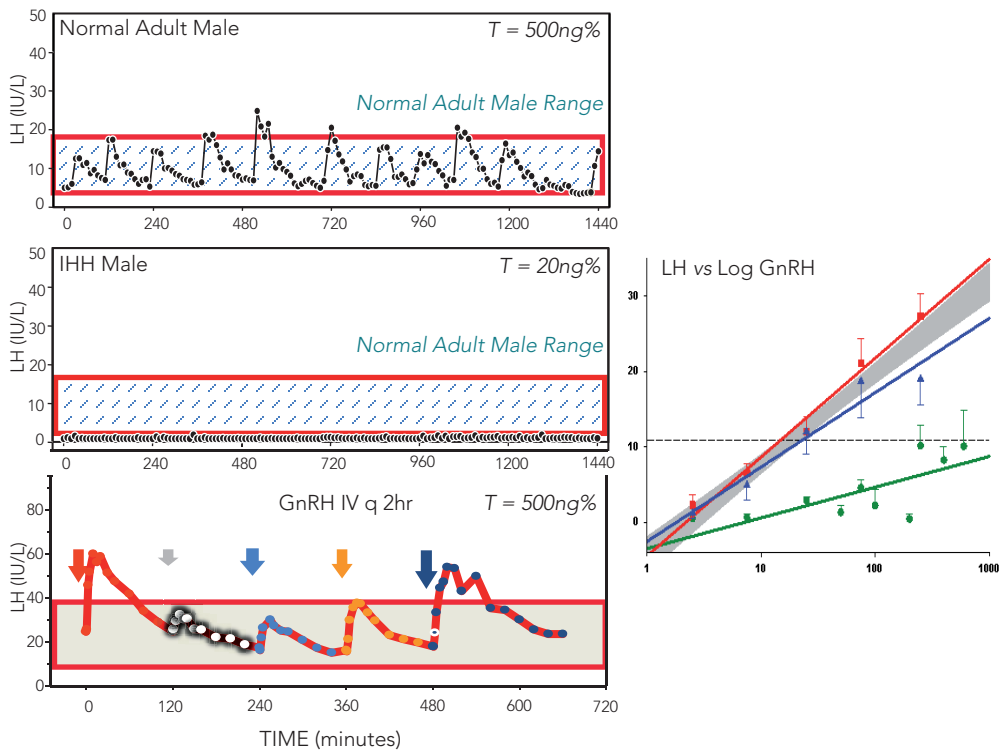

Baseline lack of endogenous LH secretion in a patient with Isolated GnRH Deficiency (upper panel); responses of several cases of IGD to pulsatile GnRH administration (middle panel); and LH responses to varied doses of pulsatile GnRH administration (lower panel). Right panel indicates the construction of dose response curves derived from the study of several IGD patients.

Source: Hoffman, Crowley, 1982 [1]; Crowley, McArthur, 1980 [2].

and phenotyped over the past 30 years, we can divide these IGD patients into different broad groups phenotypically and genetically. The first are those with anosmia/hyposmia with abnormal olfactory bulbs, i.e. patients with Kallmann Syndrome in whom all the genes and pathways discovered to date appear to share a common neuro-developmental theme and represent ~55% of all IGD cases. The remaining 45% have normal olfactory bulbs and senses of smell (normosmic Idiopathic Hypogonadotropic Hypogonadism) where a neuro-endocrine control theme is emerging (● **Figure 4**). Increasingly, however, a third category is emerging in whom mutations in several genes (FGFR1, FGF8,

● **Figure 4.** Gene classes causing IGD

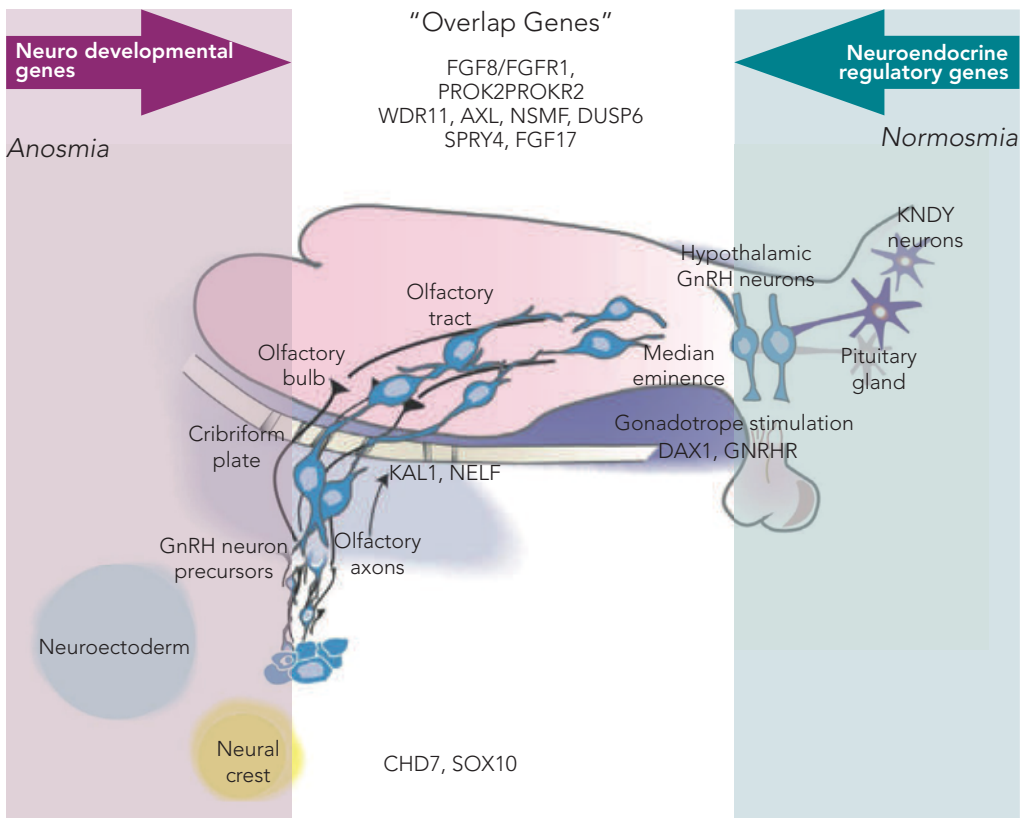

Schematic diagram of the embryonic migration pathways of GnRH neurons with various classes of underlying genetic defects. Neurodevelopmental pathway genes underlie most cases of Kallmann Syndrome whereas neuroendocrine genes seem to cause the normosmic variation. Increasingly, "overlap genes" seem to have loss of function (LoF) effects in both pathways.

PROK2/R2, etc.) exhibit phenotypic manifestations with both the impaired olfactory defect and cases lacking this defect, sometimes within the same families [6].

In 2003, using this human model of IGD, two groups discovered a new gene that controls sexual maturation in humans. By studying a consanguineous Bedouin family [7] similar to that described by a French groups a few weeks earlier [6], we noted that affected family members lacked any evidence of sexual maturation by age 18 with a normal sense of smell, i.e. they were not Kallmann Syndrome cases. This family shared a mutation in a gene that encodes a rhodopsin family member G protein-coupled receptor, GPR54, that is now referred to as the kisspeptin receptor (*KISS1R*). This receptor served as the functional GPCR for a new CNS peptide, kisspeptin [7, 8]. Functional differences between wild-type and mutant GPR54 receptors from our family *in vitro* confirmed its loss of function (LoF) status [8]. In parallel, a GPR54-deficient mouse model revealed an identical IGD phenotype. Responsiveness to exogenous gonadotropin-releasing hormone was documented in both humans and mice with mutations in *KISS1R*. Now this kisspeptin signalling system is clearly established to cause autosomal recessive IGD in mice and men. Collectively, these results established that this new kisspeptin signalling system, i.e. the ligand (*KISS1*) and its cognate receptor (*KISS1R*), are essential for normal release of GnRH at puberty. This study also gave birth to the fascinating era of the kisspeptin signalling system and the demonstration that the hypothalamic cells that contain the kisspeptin peptide also contain other neuropeptides such as neurokinin B and dynorphin. Hence they have been renamed as KNDy (kisspeptin/neurokinin B/dynorphin) neurons that, in turn, drive GnRH neurons.

Expanding this notion, single gene mutations, i.e. those that are mendelian in terms of their genetic mode of inheritance such as the kisspeptin LoF mutations, are characteristically severe and infrequent. However, as their numbers causing IGD has grown to its current ~35 (● **Figure 5**), it is now becoming possible to begin to appreciate their individual roles with some clarity. For a recent review of the genes causing this condition, how they were discovered, and what potential embryonic signalling pathways might be involved, see our recent review [6]. Also, milder and more common variants in these same “IGD Genes” are increasingly becoming associated with more common but milder reproductive outcomes such as the age of menarche and menopause [9], have surfaced via Genome Wide Associations Studies (GWAS). For example, hypothalamic amenorrhea, a common reproductive condition that occurs in 2-5% of otherwise normal women according to epidemiological studies, was previously shown by our group to be caused by a spectrum of abnormalities of their endogenous GnRH secretion [10].

Thus, hypothalamic amenorrhea’s epidemiology, frequency, as well as its complete clinical and biochemical responses to GnRH all suggested that the basic defect in this large diagnostic group of disorders involves a partial or complete inability to synthesize and/or release GnRH from the hypothalamus in the physiological mode required to produce normal reproductive function [5]. Therefore, we examined the incidence

of mutations in known “IGD genes” in patients with HA and found that 15% harboured a heterozygous, LoF mutation in known IGD genes [11].

In addition, significant oligogenicity/modifier genes account for some of incomplete penetrance/variable expressivity known to be associated with IGD [12]. Thus, this convergence of the study of Mendelian and complex genetic trait disorders offers novel and synergistic biological information regarding the genetic architecture of GnRH neurons and their role in the ontogeny of reproduction. Next generation sequencing should explode this area with new genes in the coming years.

• **Figure 5.** Timeline of major contributions to the biology of GnRH

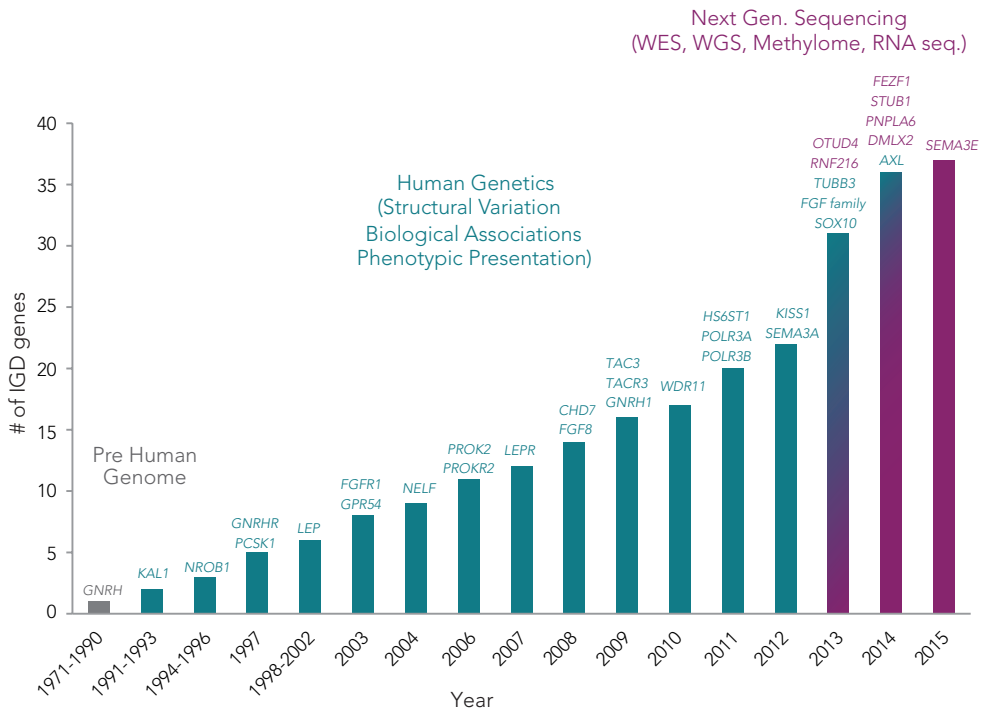

The impact of the accelerating pace of human gene discovery on the history of key biologic events in the understanding of the ontogeny of GnRH neurons.

References

[1] Hoffman AR, Crowley WF Jr. *Induction of puberty in men by long-term pulsatile administration of low-dose gonadotropin-releasing hormone.* N Engl J Med 1982 Nov 11;307(20):1237-41.

- [2] Crowley WF Jr, McArthur JW. *Simulation of the normal menstrual cycle in Kallman's syndrome by pulsatile administration of luteinizing hormone-releasing hormone (LHRH)*. J Clin Endocrinol Metab 1980 Jul;51(1):173-5.
- [3] Schwanzel-Fukuda M, Bick D, Pfaff DW. *Luteinizing hormone-releasing hormone (LHRH)-expressing cells do not migrate normally in an inherited hypogonadal (Kallmann) syndrome*. Brain Res Mol Brain Res 1989 Dec;6(4):311-26.
- [4] Bick D, Curry CJ, McGill JR, Schorderet DF, Bux RC, Moore CM. *Male infant with ichthyosis, Kallmann syndrome, chondrodysplasia punctata, and an Xp chromosome deletion*. Am J Med Genet 1989 May;33(1):100-7.
- [5] Laitinen EM, Vaaralahti K, Tommiska J, Eklund E, Tervaniemi M, Leena Valanne L, Raivio T. *Incidence, phenotypic features and molecular genetics of kallmann syndrome in Finland*. Orphanet J Rare Dis 2011;6:41.
- [6] Stammou M, Cox K, Crowley WF. *Discovering genes controlling the neuroendocrine regulation of human reproduction: adjusting to life in the “-Omics” era*. Endocrine Reviews 2015 (in press).
- [7] de Roux N, Genin E, Carell JC, Matsuda F, Chaussain JL, Milgrom E. *Hypogonadotropic hypogonadism due to loss of function of the KISS1-derived peptide receptor GPR54*. Proc Natl Acad Sci U S A. 2003 Sep 16;100(19):10972-6.
- [8] Seminara SB, Messager S, Chatzidaki EE, Thresher RR, Acierno JS Jr, Shagoury JK *et al*. *The GPR54 gene as a regulator of puberty*. N Engl J Med 2003 Oct 23;349(17):1614-27.
- [9] Day FR, Bulik-Sullivan B, Hinds DA, Finucane HK, Murabito JM, Tung JY *et al*. *Shared genetic aetiology of puberty timing between sexes and with health-related outcomes*. Nature Communications 6:8842/DOI: 10.1038/neocomms9842, 2015.
- [10] Santoro N, Filicori M, Crowley WF Jr. *Hypogonadotropic disorders in men and women: diagnosis and therapy with pulsatile gonadotropin-releasing hormone*. Endocr Rev 1986 Feb;7(1):11-23.
- [11] Caronia LM, Martin C, Welt CK, Sykiotis GP, Quinton R, Thambundit A *et al*. *A genetic basis for functional hypothalamic amenorrhea*. N Engl J Med 2011 Jan 20;364(3):215-25.
- [12] Sykiotis GP, Plummer L, Hughes VA, Au M, Durrani S, Nayak-Young S *et al*. *Oligogenic basis of isolated gonadotropin-releasing hormone deficiency*. Proc Natl Acad Sci U S A 2010 Aug 24;107(34):15140-4.

Stress, inflammation, and endometriosis

Felice Petraglia

Department of Molecular and Developmental Medicine, Obstetrics and Gynaecology, University of Siena

Endometriosis is a common benign gynaecologic disease. This condition is characterized by endometrial growth outside uterine cavity and there are three possible mechanisms of action: retrograde menstruation through Fallopian tubes, vascular and lymphatic dissemination and migration of endometrial stem cells in peritoneum. Several hypotheses have been done for the increased incidence in the last 20 years: pregnancy is postponed, diagnosis is improved and environmental contaminants are increased (epigenetics events inducing estrogen and progesterone modifications). The most common localizations are: ovary (endometrioma, OMA), peritoneum (superficial, SUP), and deep infiltrating endometriosis (DIE); even though others localizations have been described (liver, umbilicus, and lungs).

The initial event may involve deficient methylation of the estrogen receptor (ER) β promoter resulting in pathologic overexpression of ER β in endometriotic stromal cells. We speculate that alterations in the relative levels of ER β and ER α in endometrial tissue dictate E2-regulated PR expression, such that a decreased ER α /ER β ratio may result in suppression of progesterone receptor (PR). Loss of progesterone signaling in the endometrium may be a causal factor in the development of endometriosis, and progesterone resistance is commonly observed in women with this disease. In endometriotic stromal cells, the levels of PR, particularly the PR-B isoform, are significantly decreased, leading to a loss of paracrine signaling. PR deficiency likely underlies the development of progesterone resistance in women with endometriosis.

Dysfunctional macrophages and other immune cells appear to play a central role, possibly either as an underlying cause of the disease or resulting from its presence with the concomitant aberrant expression of many cytokines, enzymes and growth factors. Furthermore, angiogenesis (the growth of blood vessels) is an essential step in the

pathogenesis of the disease. Endometriotic lesions only grow if sufficiently supplied by inflammatory molecules and oxidative stress, and also the parallel growing of blood vessels and nerve fibres (neuroangiogenesis) [1]. The most common symptoms are: pain and infertility. The impaired diagnostic rates suggest that approximately 6-10% of women of reproductive age suffer from the disease.

Endometriosis and CRH

Neuroactive molecules are expressed in endometrium such as neurohormones (urocortin, CRH, prolactin, GnRH), neuropeptides (substance P) or neurotrophins (NGF) and they may play a role in the mechanisms through which nerve fibers originate in endometrium and in lesions of women with endometriosis [2].

As we know, stress induces secretion of CRH with influence on mood, food intake, and metabolism and on the neurovegetative state. Endometrial CRH and urocortin bind specific membrane receptors on endometrium (CRH R1 and CRH R2) to modulate hormonal regulation, stress and inflammation (• Figure 1) [3].

It has been demonstrated that CRH and urocortin are proportionally increased following the endometrial cycles: in the proliferative phase there is a steady state, then with ovulation the levels increase. The interesting point is that this does not happen in endometriosis: in fact CRH and urocortin levels are always stable. Urocortin increased in ovarian endometrioma and also CRH and CRH R2 in deep infiltrating endometriosis [4].

Neurogenic mechanisms are described in endometriotic lesions and they affect peripheral and central nervous system of these patients increasing pain sensitivity and

• **Figure 1.** Endometrial CRH and urocortin modulate hormonal regulation, stress, and inflammation in endometriosis

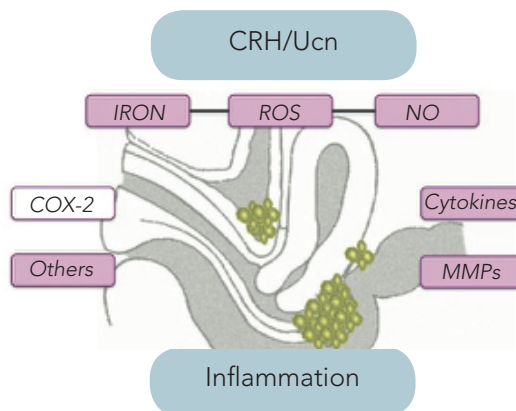

Source: modified from Tosti et al., 2015 [3].

stress reactivity and these mechanisms affect reproductive and neuroendocrine functions with a great impact of endometriosis on women's health and quality of life.

Endometriosis and stress

The widespread distribution of endometriotic lesions on both pelvic viscera and parietal peritoneum suggest that the pain associated with endometriosis may be both visceral and somatic in origin [5]. Endometriosis-associated pain is as complex as the disease itself. It is well accepted that no correlation exists between the extent of endometriosis seen at laparoscopy and the degree of pain symptoms.

OMA is generally associated with low intensity of pain, while DIE causes more frequently severe dysmenorrhea, dyspareunia and chronic pelvic pain. DIE-related pain is also associated with the highest level of stress perception, which may increase the activity of hypothalamic-pituitary-adrenal axis and brain pathways [6]. Indeed, women with endometriosis and chronic pain show alterations in central nervous system (CNS) and predispose these women to the development of additional chronic comorbidities [5]. There are many known diseases related to stress as depression, anxiety, gastritis, somatoform disorders, gastritis, psoriasis and chronic fatigue and therefore all these conditions very often are present in women with endometriosis [7]. Women with endometriosis have a lot of limitation in household chores, work activity, sport activity, sleeping, social activity, childcare and sexual relationships. Women with endometriosis have high levels of perceived stress before surgery, and repetitive surgical procedures increase the perceived stress [7].

In conclusion, endometriosis is a chronic benign gynaecological disease, caused by hormonal (high estrogens; progesterone resistance) and inflammatory dysfunction. Pain and infertility are the mayor symptoms and stress is associated in various forms with the disease. CRH is a key molecule. The correct management (medical and surgical) may improve the stress-related categories and the assessment of coping strategies, psychosexual treatment should be part of the management in women with long-term history of endometriosis [8, 9].

References

- [1] Reis FM, Petraglia F, Taylor RN. *Endometriosis: hormone regulation and clinical consequences of chemotaxis and apoptosis*. Hum Reprod Update 2013;19(4):406-18.
- [2] Gori M, Luddi A, Belmonte G, Piomboni P, Tosti C, Funghi L *et al*. *Expression of microtubule associate protein 2 and synaptophysin in endometrium: high levels in deep infiltrating endometriosis lesions*. Fertil Steril (in press).

- [3] Tosti C, Pinzauti S, Santulli P, Chapron C, Petraglia F. *Pathogenetic mechanisms of deep infiltrating endometriosis*. *Reprod Sci* 2015;22(9):1053-9.
- [4] Novembri R, Carrarelli P, Toti P, Rocha AL, Borges LE, Reis FM *et al*. *Urocortin 2 and urocortin 3 in endometriosis: evidence for a possible role in inflammatory response*. *Mol Hum Reprod* 2011;17(9):587-93.
- [5] Brawn J, Morotti M, Zondervan KT, Becker CM, Vincent K. *Central changes associated with chronic pelvic pain and endometriosis*. *Hum Reprod Update* 2014;20:737-47.
- [6] Lazzeri L, Vannuccini S, Orlandini C, Luisi S, Zupi E, Nappi RE, Petraglia F. *Surgical treatment affects perceived stress differently in women with endometriosis: correlation with severity of pain*. *Fertil Steril* 2015;103(2):433-8.
- [7] Lazzeri L, Orlandini C, Vannuccini S, Pinzauti S, Tosti C, Zupi E *et al*. *Endometriosis and perceived stress: impact of surgical and medical treatment*. *Gynecol Obstet Invest* 2015;79(4):229-33.
- [8] Luisi S, Pizzo A, Pinzauti S, Zupi E, Centini G, Lazzeri L *et al*. *Neuroendocrine and stress-related aspects of endometriosis*. *Neuro Endocrinol Lett* 2015;36(1):15-23.
- [9] Vannuccini S, Clifton VL, Fraser IS, Taylor HS, Critchley H, Giudice LC, Petraglia F. *Infertility and reproductive disorders: impact of hormonal and inflammatory mechanisms on pregnancy outcome*. *Hum Reprod Update* 2015 Sep 22. pii: dmV044 [Epub ahead of print].

Activins: more than reproductive hormones

David de Kretser

Hudson Institute, and the Department of Anatomy and Developmental Biology, Monash University, Melbourne, Victoria, Australia

Inhibins, purified in 1984, are disulphide-linked dimers and are still regarded as reproductive hormones. In females there are two forms of inhibin, A ($\alpha\beta_A$) and B ($\alpha\beta_B$), while in males there is only inhibin B.

Activins, purified in 1986, are members of the TGF β family and now are known to have many additional functions other than increasing FSH. They are disulphide-linked dimers with a molecular weight of 24-28 kDa. There are four types of activins: activin A = $\beta_A\beta_A$; activin B = $\beta_B\beta_B$; activin AB = $\beta_A\beta_B$; activin C = $\beta_C\beta_C$. The β_C subunit can bind to the other subunits and when this occurs an inactive compound is formed and this phenomenon represents a mechanism to regulate the levels of activin A and B and their biological activities.

Follistatin, purified in 1987, exerts its effects by binding the activins and can thus regulate for instance FSH levels. Follistatin binds activin virtually irreversibly with Kd 198 pM and the resulting complex is targeted to a lysosomal degradation pathway. This process is critical to the modulation of the biological activity of endogenous activin. Follistatin can also bind BMP 2,4,6,7, 15, and myostatin but with affinities that are less than 10% of its affinity for activin. Nevertheless, this binding affinity is sufficient to regulate their bioactivity. Alternative splicing of the follistatin gene produces two forms, follistatin 288 (288 amino acids) that binds to heparan sulphate proteoglycans (HSP) and is significantly bound to cell surfaces via residues 72-86 rich in basic amino acids. The other form is follistatin 315 that does not bind to heparan sulphate proteoglycans and is the predominant circulating form. Follistatin 303, so far has only been isolated in follicular fluid and arises from the proteolytic cleavage of FS 315 and its binding to HSP is of less affinity than FS288.

The amino acid sequence of activin A is conserved 100% in humans, cattle, rats and mice, while the amino acid sequence of follistatin is conserved ~97% in the above

species. This level of conservation indicates that mutations in these genes during evolution are likely to have resulted in the loss that species.

The inhibins, activins and follistatin are involved in the control of pituitary secretion of FSH. Inhibin, secreted by testis and ovary, suppresses FSH secretion acting as a long loop feedback system. Activin A is locally produced in many tissues including the pituitary gland stimulating FSH secretion. Follistatin, produced by the folliculo-stellate cells of the pituitary, locally acts as a paracrine inhibitor of FSH secretion by binding activin A.

In view of its capacity to suppress FSH, we undertook a study of the levels of follistatin after castration to determine, if as occurs with inhibin, removal of the gonads resulted in disappearance of follistatin from the circulation. To our surprise, follistatin increased significantly in serum but it also increased in sheep that had undergone a “sham” castration. This procedure involved the same anaesthesia and surgery except that the testes were not removed. These results indicated that the increase in follistatin in response to sham castration was due to the acute phase response to surgery. At this stage, we did not have an assay to measure activin A in serum. To further explore the possibility that this rise in follistatin was partly the result of an inflammatory challenge, we undertook a study to evaluate the effect giving lipopolysaccharide (LPS) to sheep.

Surprisingly, LPS resulted in a marked, rapid increase in serum activin A levels about 40 minutes after the injection. This increase in serum activin A preceded both the increase in body temperature and also, importantly, occurred before the increase in serum tumour necrosis factor α (TNF α) concentrations, an established early marker of an inflammatory response. We also demonstrated that activin A, itself is not pyrogenic, and is prostaglandin-independent. Furthermore, it is not released in central nervous system in cerebrospinal fluid concurrently with the systemic response and is not affected significantly by blocking the actions of TNF α or IL-1.

The measurements of total activin A was achieved by the use of a two-site specific ELISA using the E4 Groome monoclonal antibody [1], while total activin B was measured by a specific ELISA using a monoclonal antibody [2]. The total serum follistatin was measured by a radioimmunoassay [3]. Currently, assays to measure the “free” activin A, B and follistatin are not available.

To enable studies of the serum activin A, B and follistatin in human, we developed normal ranges for the serum levels of these proteins using serum from 142 normal volunteers with no reported serious illnesses [4]. They were aged 18 years and older and more details of this group have already been published [4] (● **Figure 1**).

These normal ranges have been essential in identifying the fact that elevated serum activin A and B levels are associated with high levels of mortality in patients with acute respiratory failure. If both activins are elevated, higher mortality results as identified in a large cohort of patients with acute respiratory failure in intensive care units [4]. The pathway through which the activins are stimulated implicates Toll 4 receptor signalling as shown in acute lung injury induced by acid or the H5N1 avian influenza virus [5].

● **Figure 1.** Normal range data for serum activin A, B and follistatin are shown as well as the activin A: follistatin and activin B to follistatin ratios, a marker of the biological activity of the activins

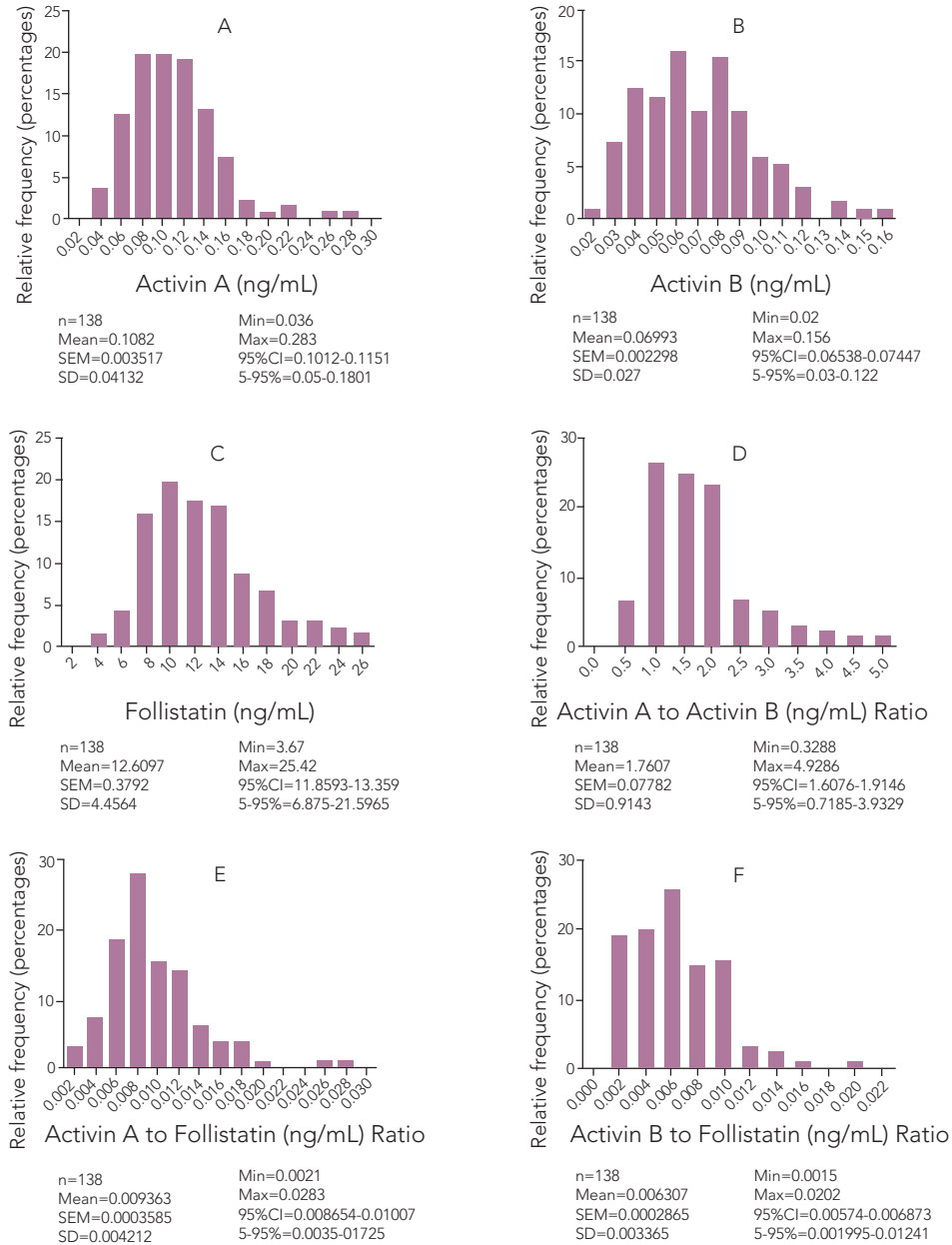

Source: de Kretser et al., 2013 [4].

In 30 patients with H1N1 influenza in intensive care, levels of serum activin A were elevated in 31%, activin B in 44% and follistatin in 41%. In 14 patients samples were available on days 0, 2 and 7 post admission. We found elevated levels of activin A (64%), activin B (86%) and follistatin (50%) (our unpublished data).

The involvement of activin A in inflammatory and fibrotic diseases is now well established in human studies such as inflammatory diseases of the lung, liver, heart, bowel and skin [6-8]. These include rheumatoid arthritis, keloids and burns injuries as well as diseases such as pulmonary hypertension in which higher levels predict a fatal outcome [7]. Although human data are not available, mouse studies clearly show that follistatin, by binding and blocking activin A could reduce mortality and the severity of the diseases such as liver fibrosis, inflammatory bowel disease, wound healing and burns injuries [8].

Given the significant negative effect of elevated activin levels such as apoptosis of hepatocytes and B-lymphocytes, there are emerging prospects of blocking the biological actions of the activins by follistatin or soluble activin receptor blockers (● Figure 2).

● **Figure 2.** Schematic representation highlights the central role of the actions of activin A and B in the control of inflammation and fibrosis

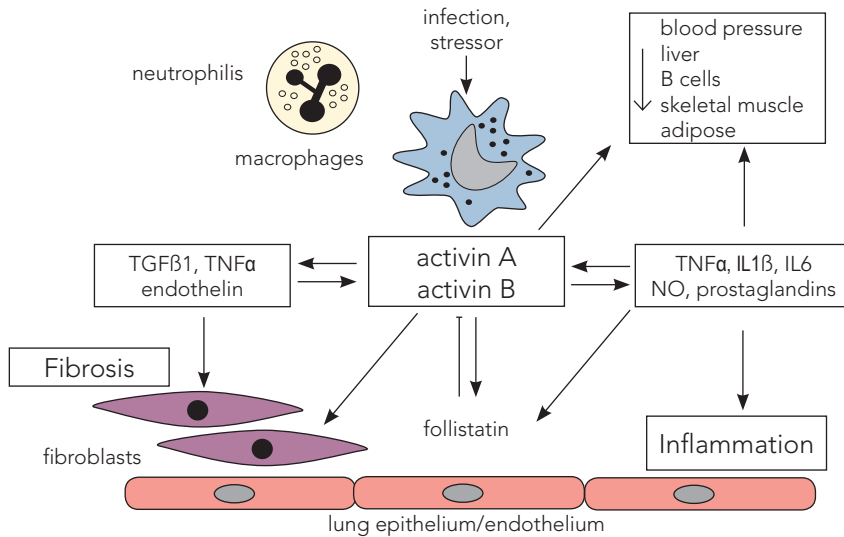

Source: de Kretser et al., 2013 [4].

Activin and follistatin in transplantation biology

Given that organs for transplantation are devoid of a blood supply for varying periods of time and accumulate reactive oxygen species and other cellular products as-

sociated with cell death, reperfusion results in an ischaemia reperfusion injury (IRI) causing an inflammatory response. Given that IRI is stimulated via Toll receptors, especially TLR4 and since the activin A response to inflammation is also TLR4 dependent, we explored the possibility that activin A was involved in IRI.

Using blood samples from patients undergoing bilateral sequential lung transplants for respiratory failure who were involved in a randomised trial of remote ischemia preconditioning (RIP), we assessed the activin A response in blood samples taken before the induction of anaesthesia, and at time intervals up to 24 hours after the transplantation of the lungs. The RIP was delivered by 3 cycles of 5 minutes of ischemia and 5 minutes of reperfusion using a thigh tourniquet with controls having an uninflated tourniquet applied to their thigh. There were no significant differences in the serum activin A responses between the groups of patients who received RIP and those who did not. Timing of RIP was such that the patient had a minimum of 5 minutes limb reperfusion before the first lung is reperfused. Lungs were then sequentially transplanted. There was a dramatic increase in the levels of serum activin A response in the initial phase, as shown in **Figure 3**.

The cause of the marked increase in serum activin A is complex as there are a range of factors responsible. These include the acute phase response that has been shown to increase activin A levels [9]. The second is the inflammatory response associated with IRI and the third is the use of heparin [10]. In this study, boluses of heparin (2500-5000 units), were given just prior to induction of anaesthesia and subsequently to maintain activated clotting times at twice baseline, with each patient receiving an average of 5000 IU. Given that heparin is negatively charged, it has the capacity to displace activin-follistatin complexes from basement membranes throughout the body.

The activin A and follistatin levels remain elevated at 2 hours, but became normal at 8-hour post reperfusion. Heparin is certainly involved because it releases activin and follistatin. The donor also receives 2,500 units of heparin just prior to clamping the donor pulmonary artery subsequent to which the vasculature is perfused with a preservation solution. The use of heparin is relevant since follistatin 288 binds to HSP and is significantly tissue bound via residues 72-86 rich in basic amino acids. Heparin releases activin and follistatin since its negative charge releases the activin-follistatin complex from basement membranes as shown by Jones *et al.* [10].

In conclusion, lung transplantation is associated with a rapid and sustained release of activin A and follistatin in serum. A major part of this response is due to the acute phase response to surgery with an added component due ischaemia reperfusion injury. The magnitude of the increase in activin A is augmented by the use of heparin during transplant surgery and thus the use of lepirudin, a non-heparin anti-coagulant, has the potential to decrease the magnitude of the activin A and follistatin release as shown in the study by Chen *et al.* [11].

● **Figure 3.** Changes in serum activin A levels during the process of lung transplantation surgery in patients undergoing bilateral sequential lung transplantation who were randomised to groups who did and did not receive remote ischaemia preconditioning

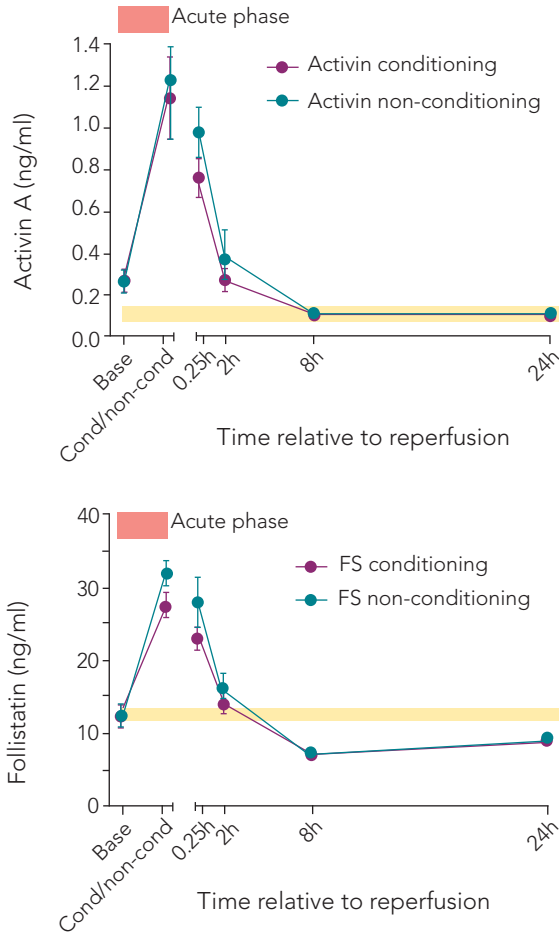

Source: de Kretser et al., 2015 [12].

References

[1] Knight PG, Muttukrishna S, Groome NP. *Development and application of a two-site enzyme immunoassay for the determination of "total" activin-A concentrations in serum and follicular fluid.* J Endocrinol 1996;148(2):267-79.

- [2] Ludlow H, Phillips DJ, Myers M, McLachlan RI, de Kretser DM, Allan CA *et al.* *A new 'total' activin B enzyme-linked immunosorbent assay (ELISA): development and validation for human samples.* Clin Endocrinol (Oxf) 2009;71(6):867-73.
- [3] O'Connor AE, McFarlane JR, Hayward S, Yohkaichiya T, Groome NP, de Kretser DM. *Serum activin A and follistatin concentrations during human pregnancy: a cross-sectional and longitudinal study.* Hum Reprod 1999;14(3):827-32.
- [4] de Kretser DM, Bensley JG, Pettilä V, Linko R, Hedger MP, Hayward S *et al.* *Serum activin A and B levels predict outcome in patients with acute respiratory failure: a prospective cohort study.* Crit Care 2013;31;17(5):R263.
- [5] Imai Y, Kuba K, Neely GG, Yaghubian-Malhami R, Perkmann T, van Loo G *et al.* *Identification of oxidative stress and Toll-like receptor 4 signaling as a key pathway of acute lung injury.* Cell 2008;18;133(2):235-49.
- [6] Yu EW, Dolter KE, Shao LE, Yu J. *Suppression of IL-6 biological activities by activin A and implications for inflammatory arthropathies.* Clin Exp Immunol 1998;112(1):126-32.
- [7] Yndestad A, Ueland T, Øie E, Florholmen G, Halvorsen B, Attramadal H *et al.* *Elevated levels of activin A in heart failure: potential role in myocardial remodeling.* Circulation 2004;109(11):1379-85.
- [8] Dohi T, Ejima C, Kato R, Kawamura YI, Kawashima R, Mizutani N *et al.* *Therapeutic potential of follistatin for colonic inflammation in mice.* Gastroenterology 2005;128(2):411-23.
- [9] Jones KL, de Kretser DM, Patella S, Phillips DJ. *Activin A and follistatin in systemic inflammation.* Mol Cell Endocrinol 2004 Oct 15;225(1-2):119-25.
- [10] Jones KL, De Kretser DM, Phillips DJ. *Effect of heparin administration to sheep on the release profiles of circulating activin A and follistatin.* J Endocrinol 2004;181(2):307-14.
- [11] Chen Y, Phillips DJ, McMillan J, Bedford P, Goldstein J, Wu H *et al.* *Pattern of activin A and follistatin release in a sheep model of cardiopulmonary bypass.* Cytokine 2011;54(2):154-60.
- [12] de Kretser DM, Bensley J, Phillips D, Levvey BJ, Snell GI, Lin E *et al.* *Substantial increases occur in serum activins and follistatin during lung transplantation.* PlosOne 2015 D-15-33006R1 (in press).

Nuclear receptors and “Diabetes”: a roadmap to human health

Ronald Evans

Salk Institute, La Jolla, California, USA

To study metabolism, it is necessary to not only understand the individual contributions of different tissues, but to also consider the complex interactions between tissues. For example, the function of adipose tissue is to store excess energy, while muscle is designed to burn energy. Somehow the body needs to coordinate these opposing actions (• **Figure 1**). As metabolic sensors, nuclear receptors are pleiotropic regula-

- **Figure 1.** Nuclear receptors and the metabolic pyramid

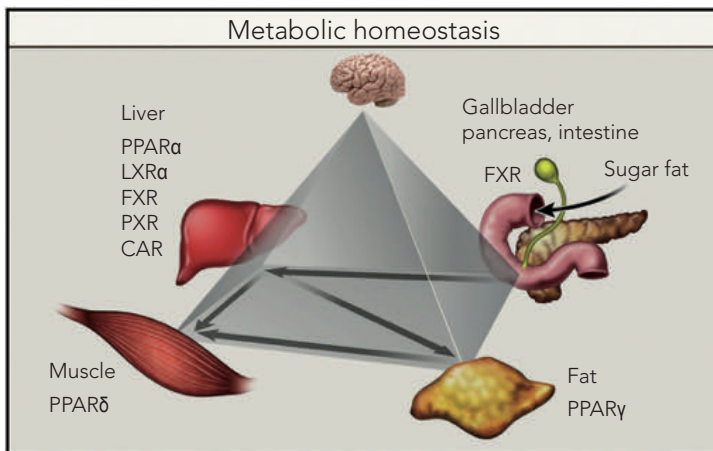

Nuclear receptors expressed in the major metabolically relevant tissues regulate nutrient usage/storage to maintain metabolic homeostasis.

Source: Evans, Mangelsdorf, 2014 [1].

tors of metabolism that play major roles in this communication through coordinating transcriptional activity in metabolically relevant tissues. Thus, nuclear receptors (NRs) are not only implicated in the etiology of metabolic diseases including diabetes, metabolic syndrome and obesity, but are validated therapeutic targets for disease treatments.

In exploring the roles of NRs in diabetes, we uncovered a potentially new physiologic pathway. A biased screen linking NRs to nutrient stress implicated the fibroblast growth factor 1 (FGF1) – the foundational member of the FGF family – as a novel metabolic regulator. Indeed, we found that the expression of FGF1 in the adipose depot is induced by high-fat diet, and that this induction is mediated by the nuclear receptor PPAR γ . Remarkably, this metabolic role of FGF1 had remained hidden for the 30 years since its discovery, despite extensive research studies.

All species have evolved to survive unpredictable periods of feast and famine through dynamic energy stores in adipose depots. Our studies reveal that a previously unrecognized role of FGF1 in adipose remodelling is central to this process. A comparison of adipose tissue in fasted, normal diet, and high-fat diet (HFD)-fed mice identified a dramatic increase in FGF1 coincident with energy intake. Interestingly, while FGF1 knockout mice previously had no discernible phenotype, leading to the notion that FGF1 was not essential, these mice had not been metabolically challenged. Our study showed that FGF1 knockout mice become insulin resistant when stressed by a HFD (● [Figure 2](#)). Close examination revealed the presence of extensive fibrosis in the adipose tissue of the FGF1 KO mice that compromises the ability of the tissue to appropriately expand and contract in response to nutrient levels. Consistent with this observation, extensive triacylglycerol accumulation is seen in the livers of the KO mice fed a HFD.

These studies indicate that FGF1 is required under conditions of nutrient overload or “feast”. We next asked whether FGF1 is required during fasting or “famine” conditions. To address this question, HFD-fed FGF1 KO mice were converted to a normal chow diet. Remarkably, the FGF1 KO mice displayed a more extreme adipose phenotype when converted to normal chow. A comparison of gene transcription between wild type and FGF1 KO mice revealed the induction of a gene signature consistent with tissue necrosis, including a dramatic induction of pancreatic lipases. Thus, FGF1 appears required for both the expansion of adipose tissue when excess nutrients are available, as well as in its contraction during fasting.

Based on these studies, we propose that environmental signals such as nutrient levels are sensed by the nuclear receptor PPAR γ , which induces the expression of FGF1 – the transducer – to drive adipose remodelling. Inherent in this model is the association of normal levels of FGF1 with insulin-sensitivity and inadequate levels of FGF1 with insulin-resistance (● [Figure 3](#)).

Subsequent studies revealed that parenteral delivery of a single dose of recombinant FGF1 (rFGF1) results in potent, insulin-dependent lowering of blood glucose levels in diabetic mice [2]. Notably, while the glucose-lowering effects of FGF1 are

• **Figure 2.** HFD-fed FGF1 knockout mice are insulin resistant

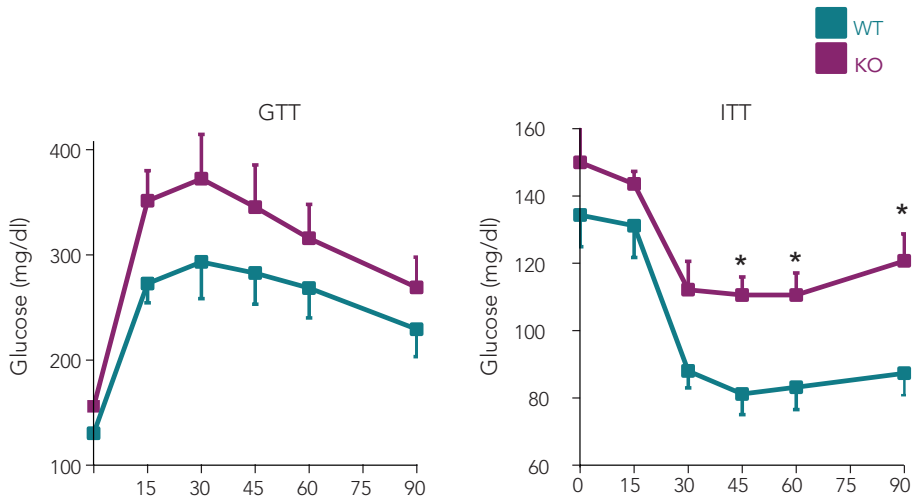

FGF1 knockout mice (KO) display higher glucose excursions during a glucose tolerance test (GTT), and are less responsive during an insulin tolerance test (ITT) than wild type mice.

Source: Jonker *et al.*, 2012 [3].

• **Figure 3.** FGF1 is required for adipose remodelling

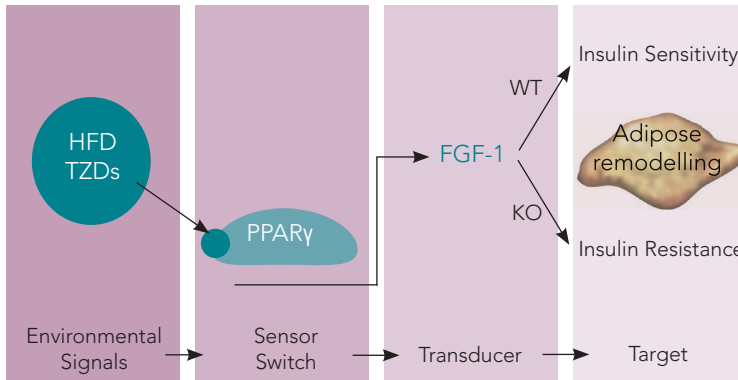

In response to a dietary or pharmacological signals, PPAR γ induces the expression of FGF1 to remodel adipose tissue. Failure to appropriately remodel adipose tissue leads to insulin resistance.

Source: Jonker *et al.*, 2012 [3].

dose-dependent, rFGF1 does not lead to hypoglycaemia, an important factor for a potential diabetic drug. Furthermore, chronic treatment with rFGF1 increases insulin-dependent glucose uptake in skeletal muscle and suppresses hepatic glucose production to achieve whole-body insulin sensitization. The sustained glucose lowering activity and insulin sensitization attributed to rFGF1 treatment are not accompanied by the side effects of weight gain, liver steatosis and bone loss associated with current insulin-sensitizing therapies. Mechanistically, we show that the glucose-lowering activity of rFGF1 is mediated via the FGF receptor 1 in adipose tissue. Furthermore, we found that this activity can be dissociated from its mitogenic activity, an important finding for its potential as a novel therapy for diabetes [2].

Another example of the regulatory function of NRs in maintaining metabolic homeostasis is illustrated by systemic effects of the bile acid receptor, farnesoid X receptor (FXR). Bile acids were originally described as detergent molecules involved in the digestion and absorption of dietary lipids in the intestine. Produced in the liver as end products of cholesterol metabolism, bile acids are also implicated in cholesterol homeostasis. More recently, bile acids have been recognised as hormones with key roles in metabolic homeostasis. In particular, bile acids have been identified as the endogenous ligands for FXR, and the G protein-coupled receptor TGR5.

The release of bile acids into the intestines serves not only to aid absorption, but also activates FXR expressed throughout the intestine. Notably, circulating bile acids also activate FXR expressed in other tissues including the liver, kidney and adrenal glands. To explore the role of intestinal FXR activation in metabolic homeostasis, we developed a potent and selective FXR agonist termed Fexaramine. This molecule is poorly absorbed from the gut such that oral dosing efficiently activates FXR in the intestine, but fails to activate FXR in the liver. Thus, oral exposure to this tissue-selective FXR activator effectively mimics the feeding response. Treatment of mice with Fexaramine induces expression of the enteric fibroblast growth factor 15 (FGF15), leading to alterations in bile acid composition, but it does so without activating FXR target genes in the liver.

However, unlike systemic agonists, Fexaramine treatment reduces diet-induced weight gain, body-wide inflammation and hepatic glucose production (● **Figure 4**) [4].

Oral dosing of Fexaramine reduces systemic inflammation in HFD-fed mice, with dramatic reductions in the level of TNF, as well as lower levels of IL-1 α , IL-1 β , IL-17 and MCP-1. In addition, Fexaramine treatment induces the expression of FGF15 (FGF19 in humans) in the intestine. This endocrine factor circulates through the blood to beneficially affect metabolic parameters throughout the body, including decreasing insulin, cholesterol, and bile acid levels, and reducing the levels of the metabolic hormones leptin and resistin. In addition, FGF15 reduces hepatic gluconeogenesis to improve glucose homeostasis (● **Figure 4b**). Furthermore, Fexaramine treatment induces a thermogenic response in mice, in part through the browning of

● **Figure 4.** Intestinally-biased activation of FXR improves whole body metabolism

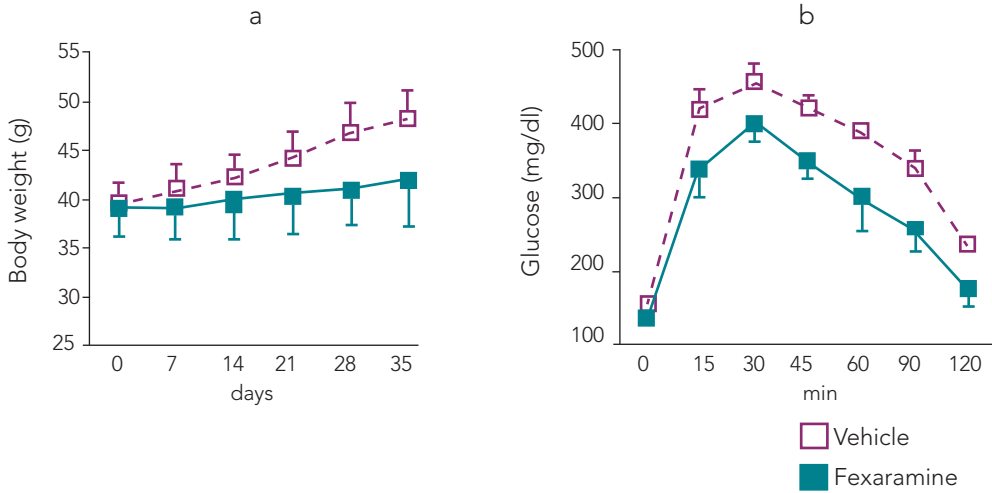

Fexaramine treatment reduced weight gain (a) and improved glucose tolerance (b) in HFD-fed mice.

Source: Fang *et al.*, 2015 [4], modified.

white adipose tissue, to enhance energy expenditure. Consistent with this, Fexaramine treatment enhances the expression of genes involved in oxidative phosphorylation leading to an increase in oxygen consumption.

In addition to the systemic effects of Fexaramine, activation of FXR in the intestine has profound effects on gut health. The proteins occludin, important for restricting translocation of gut bacteria into the blood stream, and Muc2, that functions as an intestinal barrier, are increased with FXR activation to improve mucosal defence. At the same time, Fexaramine affects the microbiome, decreasing the total number of bacteria that lives in the gut as well as reducing the levels of pathogenic bacteria.

In summary, FXR is a mediator of normal postprandial physiology. Gut-restricted FXR activation by Fexaramine mimics these changes, resulting in reduced fat mass and improved metabolic parameters in a mouse model of obesity (● **Figure 5**). Notably, FXR mediates the metabolic benefits following bariatric surgery [5]. Thus, gut-restricted FXR activation has translational potential for some very common health problems like obesity, type 2 diabetes and non-alcoholic fatty liver disease.

• **Figure 5.** FXR regulates whole body metabolism

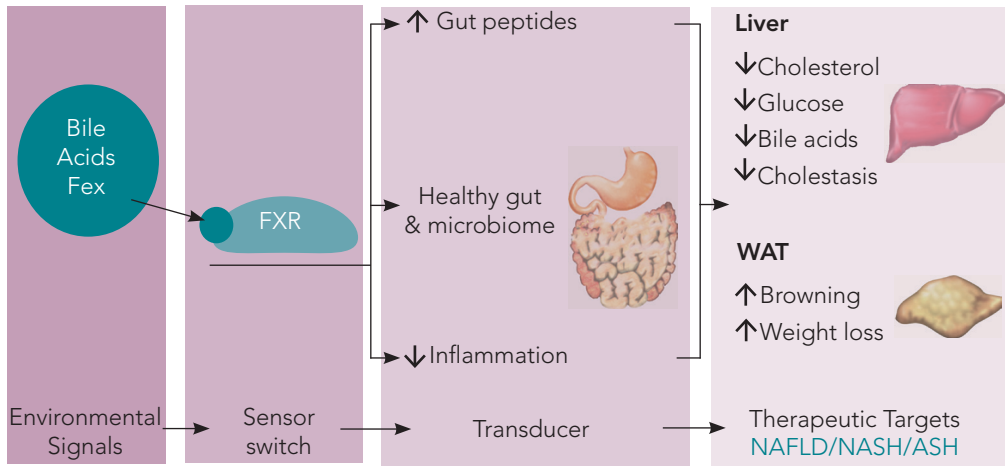

Postprandial activation of intestinal FXR by bile acids improves gut health and reduces inflammation. In addition, FXR activation induces the secretion of gut hormones that affect metabolic tissues, including the liver and white adipose tissue (WAT), to improve metabolic homeostasis. The small molecule FXR agonist, Fexaramine, mimics the beneficial effects of FXR activation and may be a potential therapeutic for diseases such as non-alcoholic fatty liver disease (NAFLD), non-alcoholic steatohepatitis (NASH), and alcoholic steatohepatitis (ASH).

References

- [1] Evans RM, Mangelsdorf DJ. *Nuclear Receptors, RXR, and the Big Bang*. Cell. 2014; 157:255-66.
- [2] Suh JM, Jonker JW, Ahmadian M, Goetz R, Lackey D, Osborn O *et al*. *Endocrinization of FGF1 produces a neomorphic and potent insulin sensitizer*. Nature 2014;513:436-9.
- [3] Jonker JW, Suh JM, Atkins AR, Ahmadian M, Li P, Whyte J *et al*. *A PPAR γ -FGF1 axis is required for adaptive adipose remodelling and metabolic homeostasis*. Nature 2012;485:391-4.
- [4] Fang S, Suh JM, Reilly SM, Yu E, Osborn O, Lackey D *et al*. *Intestinal FXR agonism promotes adipose tissue browning and reduces obesity and insulin resistance*. Nat Med 2015;21:159-65.
- [5] Ryan KK, Tremaroli V, Clemmensen C, Kovatcheva-Datchary P, Myronovych A, Karns R *et al*. *FXR is a molecular target for the effects of vertical sleeve gastrectomy*. Nature 2014;509:183-8.

SESSION 3

STRESS, INFLAMMATION,
AND REPRODUCTIVE MEDICINE

Stress-induced anovulation: mind over matter?

Sarah L. Berga

Department of Obstetrics and Gynecology, Section of Reproductive Endocrinology & Infertility, Wake Forest School of Medicine, Winston-Salem, North Carolina, USA

There are many health consequences of chronic stress. The exposure to socio-environmental stressors that are unrelenting, unpredictable, or unresolvable induces a cascade of neurobehavioral responses that includes dysregulation of limbic-hypothalamic-pituitary-adrenal (LHPA) axis, chronic activation of sympathetic nervous system (SNS), and behavioral coping (adaptive or maladaptive). There are many potential consequences: affective disorders, reward deficits, immune dysfunction, disordered eating. In this chapter we will focus on reproductive consequences of chronic stress using the model of stress-induced anovulation (SIA), often termed functional hypothalamic amenorrhea (FHA).

To understand how stress impacts reproduction, we must understand the metabolic demands of reproduction and define the cognitive features that increase sensitivity to commonplace stressors. Cognitions or attitudes that are associated with SIA/FHA include perceived lack of control, which in an animal model is often termed social subordination, perfectionism, high need for social approval (sometimes termed external locus of control), and overly high expectations of self and/or others [1].

Metabolic and psychogenic stressors induce a constellation of neuroendocrine adaptations. The proximate cause of the anovulation is the slowing of GnRH pulsatility to the point that there is insufficient GnRH to drive to the pituitary release of gonadotropin levels of FSH and LH to fully support folliculogenesis. However, stress-induced suppression of GnRH does not occur in isolation. At a minimum, there are always two other concomitant neuroendocrine alterations: reduction in thyroid hormone and an increase in cortisol. Said another way, there is a constellation of neuroendocrine aberrations that always travel together.

A wonderful example of constellation of stress-induced neurohormonal adaptations is the study of Loucks and Thurma in which administering graduated reductions in dai-

ly calorie intake of 40, 60 and 80% to ovulatory women was studied. The greater the calorie reduction, the greater will be the impact upon reproduction and other hormonal measures. A daily calorie reduction of 80% reduced circulating glucose by 15% and LH pulse frequency (a surrogate for GnRH pulse frequency) by 40% while simultaneously increasing cortisol [2]. Why is energy availability so important for reproduction? The energy required for pregnancy and lactation is considerable. For instance, it takes 13 million calories to raise a human from birth to maturity [3]. The tissue that most depends on calories is the brain. The infant brain requires the 60% of its daily energy intake. The adult brain requires 25% of daily calorie intake yet receives only 16% of cardiac output despite being 2% by weight. Metabolically, brain is a very expensive tissue!

Functional hypothalamic amenorrhea (FHA)/stress-induced anovulation (SIA) is a diagnosis of exclusion. Making the diagnosis is complicated by the fact that there is a spectrum of menstrual cycle compromise due to a synergism between energetic imbalance and psychogenic challenge [4].

Reindollar *et al.* (1986) described the causes of amenorrhea. The most common cause was functional hypothalamic amenorrhea (34%) followed primarily by hyperandrogenism and PCOS [5]. There are also genetic causes of hypothalamic amenorrhea (HA) that have been described that interfere with GnRH neuronal functioning and these include GNRHR, KAL1, PROKR2, FGFR1, GPR54, FGF8 and PROK [6].

- **Figure 1** shows the conventional dictum regarding the pathogenesis of functional HA. To better understand the contributing factors, we looked at 3 categories: neurobiological factors, metabolic deficits, and psychogenic variables.

We started our investigations with the simple hypothesis that as cortisol rose, LH pulses frequency would decrease. We posited that although there might be sex differences in sensitivity to stressors, the GnRH pulse generator of both men and women would be suppressed by commonplace stressors. To understand the “signature of stress”, we looked at circulating and CSF levels of cortisol. In our study by Brundu *et al.*, we ob-

- **Figure 1.** Pathogenesis of FHA: conventional dictum

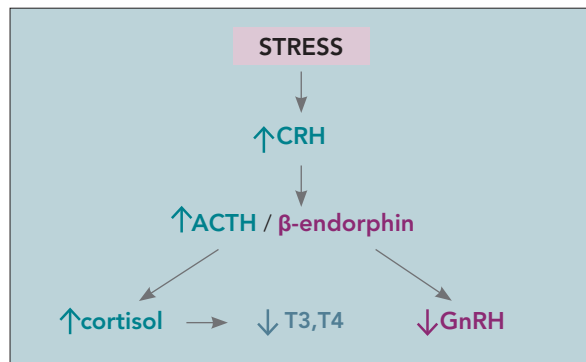

tained 25 ml of cerebrospinal fluid (CSF) and utilized the most rostral 5 ml to measure ligands of interest (• **Figure 2**) [7, 8], including CRH. To define the diurnal circulatory pattern of cortisol, we obtained blood samples at 15 minute intervals for 24 hours. We were surprised to find that CRH levels were comparable in women with SIA/FHA and eumenorrheic ovulatory women even when the women with SIA/FHA had elevated levels of circulating cortisol. We then measured cortisol in the CSF and we found that it was 20-25% higher in women with SIA/FHA as compared to eumenorrheic ovulatory women. These results led us to posit that the circulation has a buffering mechanism which is the stress-induced increase in hepatic CBG while the neuroaxis does not. Thus the stress signal is amplified at the brain level while the effects of stress are minimized in the peripheral compartment. As cortisol rises in the circulation, the liver production of cortisol binding protein rises and the free fraction of cortisol during stress is minimized while the cortisol in the CSF, which is unbound, is amplified. The peripheral buffering mechanism likely explains why chronic stress does not lead to a Cushingoid appearance.

• **Figure 2.** Cortisol and CRH levels in cerebrospinal fluid (CRF) samples

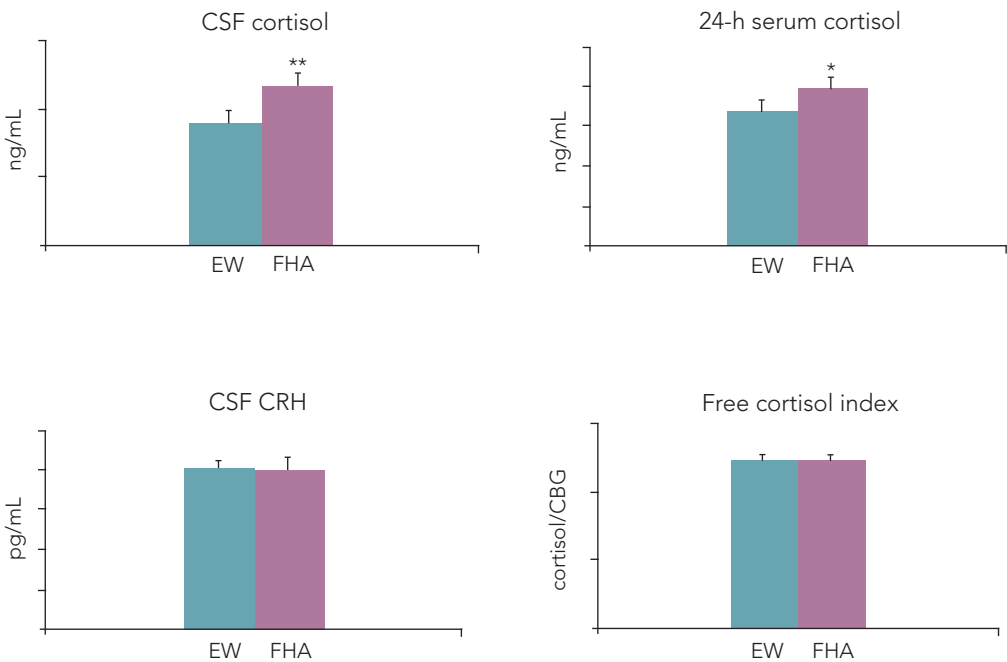

Source: Brundu et al., 2006 [8].

We only studied women with HA who were of normal weight and we excluded those with eating disorders and other psychiatric disorders. We observed that T3 is remarkably suppressed but TSH is not elevated, indicating increased central sensitivity to thyroidal feedback that would confer energy conservation by reducing basal metabolic rate. This adaptation has been termed hypothalamic hypothyroidism and is an obligatory consequence of chronic stress. Chronic adaptations to persistent stress lead to a state referred to as allostasis: the hypothalamic-pituitary-ovarian (HPO) axis is insensitive to decreased ovarian steroid secretion. In essence, the brain is notified and “doesn’t care” that there is anovulation and hypoestrogenism. The hypothalamic-pituitary-adrenal (HPA) axis also displays altered feedback inhibition, with increased cortisol in circulation and CSF while cortisol releasing hormone (CRH) levels are preserved. To reduce cortisol, the CSF CRH levels should fall. Preserved CRH levels in the face of elevated cortisol levels indicate feedback resistance to cortisol at the central level. Likewise, T3 and T4 are decreased without a compensatory rise in TSH, indicating altered central feedback.

In summary, stress causes suppression of GnRH drive and secondary anovulation with hypoestrogenism, increased CRH drive and secondary hypercortisolism, decreased TRH input and secondary hypothyroidism (sick euthyroid syndrome), altered appetite signaling and responses to appetite signals with consequent weight gain or loss depending on circumstances. Responses to appetite signals basically depend on the availability of food when you’re stressed. The availability of comfort food increases the probability that stress will lead to overeating.

To better understand how stressors interacted, we utilized a monkey model. The monkeys were placed on a treadmill and allowed to run 2 miles daily. Their calorie intake was reduced by 20%. The social stress was moving their cages to new rooms. Calorie restriction and running led to about 10% of the monkeys developing transient anovulation. Moving also led to about 10% of the monkeys developing transient anovulation. However, the combination of the social stress of moving combined with the metabolic stress of exercise and calorie restriction caused 75% of the monkeys to develop transient anovulation [9].

The human analog of this model is shown in • **Figure 3**. Women with amenorrhea who were of normal body weight were given an exercise challenge. Of note, the exercise challenge induced a decline in glucose levels only in HA and not in eumenorrheic women. Despite comparable BMI, women with SIA/FHA women were unable to keep up with the energetic demands of sub-maximal energy expenditure. In addition, exercise resulted in greater HPA (adrenal) activation in HA women as compared to eumenorrheic ones (EW). Conventional wisdom holds that exercise is a good way to manage stress, but our results suggest that exercise increases stress at the endocrine level.

• **Figure 4** shows the many neurobiological factors that have been posited to modulate GnRH pulsatility. To understand their independent impact is difficult. GAB-

● **Figure 3.** Amplified cortisol response to exercise challenge in FHA vs eumenorrheic women likely elicited by drop in glucose

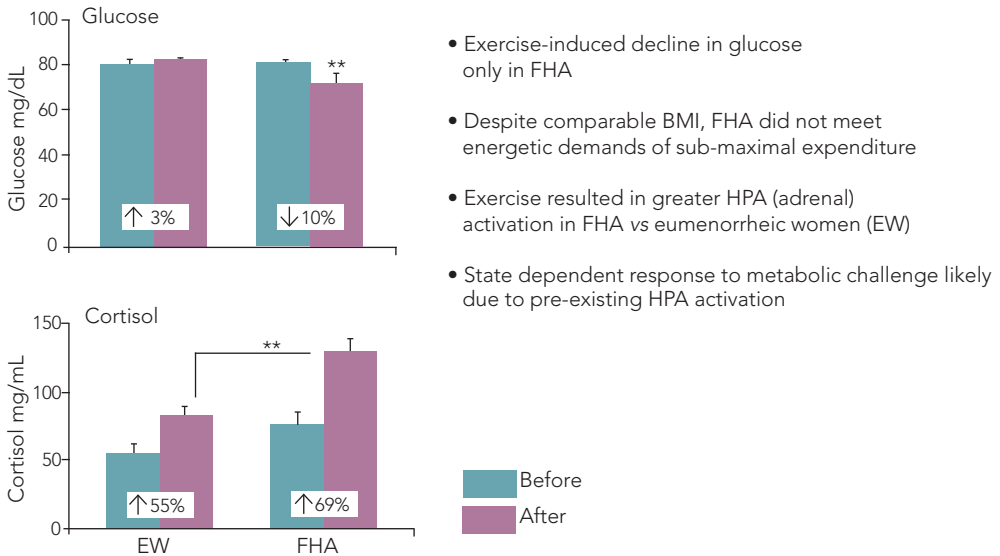

Source: Loucks et al., 2003 [10].

Aergic neurons may integrate the many signals and communicate to the neurons that regulate GnRH. If so, one would expect stress to alter GABAergic function.

To delineate the impact of the chronic psychosocial stress of subordination upon GABA-A receptor binding in limbic regions implicated in emotional processing, we neuroimaged 17 adult female rhesus monkeys (ovariectomized + E2) using positron emission tomography (PET) with 18F-flumazenil as a neuroprobe and co-registered T1-weighted structural MRI scans to perform a region of interest (ROI) analysis using the pons as a reference region. To interrogate the role of stress, we compared GABA-A receptor binding in dominant and subordinate monkeys before and after peripheral administration of a corticotropin-releasing hormone (CRH) receptor antagonist (astressin B) (● **Figure 5**) [11].

Our results show that GABAergic receptor binding differed between dominants and subordinates in prefrontal cortex and that CRH receptor antagonism (astressin B) reversed the differential impact of social subordination upon central GABA-A receptor binding in prefrontal cortex [11].

How this is related to the human condition of SIA/FHA? If we accept the notion that psychogenic challenge and metabolic deficits synergize to disrupt GnRH drive and that

• **Figure 4.** GnRH pulsatility

GnRH Pulse Generator and Its Modulation

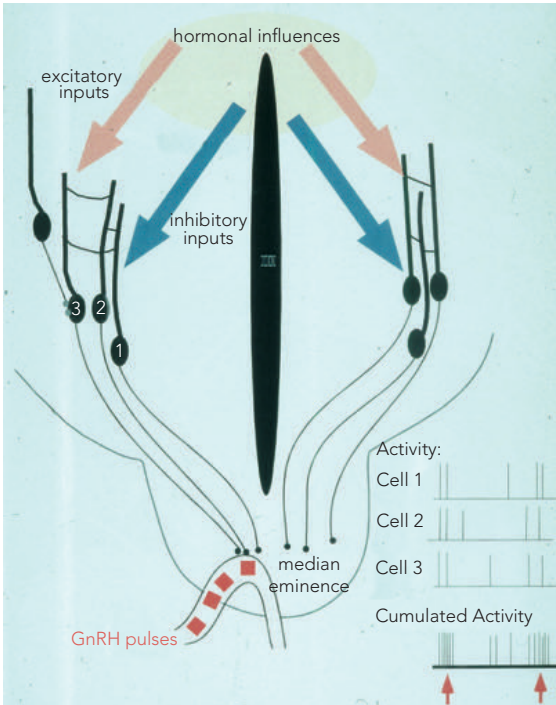

- | | |
|------------------------------|------------------|
| CRH/HPA | Immune |
| Opioids | Autonomic |
| Kisspeptin | Sex steroids |
| Metabolic signals | Gonadal proteins |
| Orexigenic signals (ghrelin) | Growth factors |
| Serotonin | Glial cells |
| GABA | GnRH |
| Dopamine | Other |

GnRH to GnRH connections

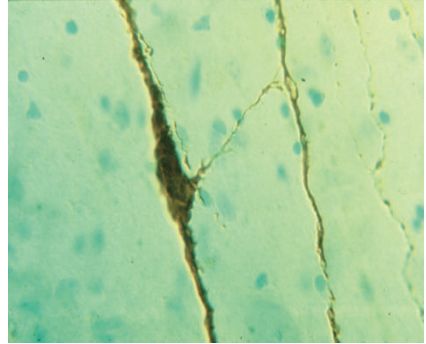

NPY synapses on GnRH neurons

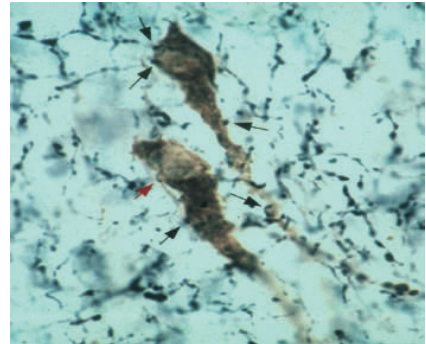

Source: The two parts on the right side are unpublished neuroimmunocytochemistry of the medial basal hypothalamus from Gloria E. Hoffman, PhD. The left diagram was adapted from Berga et al., 1999 [12].

SIA/FHA is more than an isolated disruption of GnRH drive, than we need a treatment plan that will reduce the proximate causes (the stressors). We hypothesized that stress reduction would ameliorate the entire constellation of neuroendocrine aberrations.

Further, we know that stress reduction is important because stress causes more than reproductive impairment. Chronically elevated levels of cortisol predisposes to oste-

● **Figure 5.** Representative example of GABA-A receptor binding in different regions

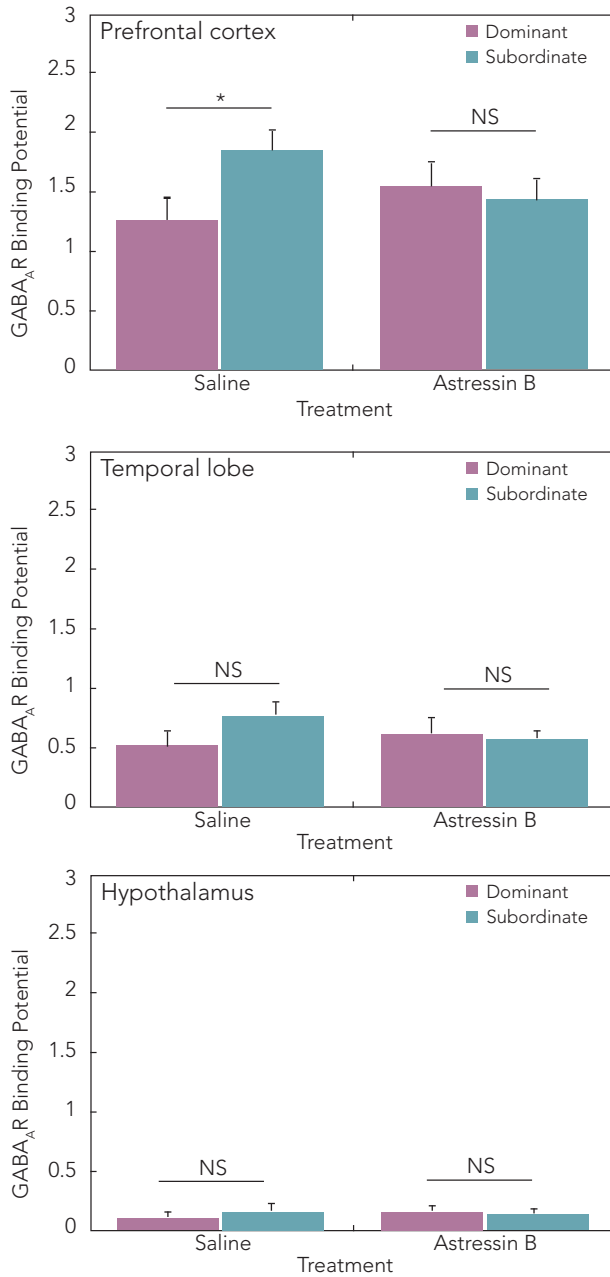

Source: Michopoulos et al., 2013 [12].

oporosis, cardiovascular disease, altered libido, infertility, and syndromal psychiatric disease. Chronic stress may shorten telomeres, alter epigenetics, and accelerate aging. Simply giving sex steroid therapy or inducing ovulation will not correct the panoply of neuroendocrine aberrations nor foster long-term health.

To manage stress, we must understand the stressors. We used psychometric inventories to help us gauge attitudes that might make a person sensitive to commonplace stressors. We found that women who are more sensitive to stress have unrealistic expectations of self and others, are perfectionistic, and have a high need for social approval (conflicting aims). They demonstrated poor problem solving and coping skills but unexpectedly did not have an excess history of negative life events nor meet criteria for depression, other psychiatric conditions, or eating disorders [13]. For these women, we posited that cognitive behavior therapy (CBT) would offer an efficacious treatment option. The aim of CBT was to change attitudes rather than behaviors. The CBT program consisted of 16 sessions of 45 minutes administered over 20 weeks. CBT sessions focused on problem solving strategies and coping mechanisms, good nutrition, and developing a sensible exercise regimen. We randomized women with SIA/FHA to either CBT or observation and found that 75% of the women treated with CBT resumed ovulation while only 25% who were observed did [14]. In addition, CBT reduced circulating cortisol in FHA during the nocturnal phase when cortisol levels were most elevated [15]. Body weight remained unaltered but the drop in cortisol was associated with increased leptin and TSH suggesting metabolic recovery independent of weight change.

An important question that deserves further attention is the impact of stress during pregnancy. Given that it is possible to induce ovulation in women with SIA/FHA and to “override” the brain’s decision to suppress reproduction, we need to understand the health consequences of doing so. Will maternal stress impact the course of pregnancy and differentially impact male vs female offspring? In a recent study, using microarray analysis, 2000 more hormone responsive genes were detected in female than in male rats given a standard dose of a synthetic glucocorticoid. 70 genes showed opposite changes in expression in males and females and genes regulating inflammation were more suppressed in males. Furthermore male rats had higher survival when given GC during exposure to infection and female rats had lower rates of survival, suggesting important sex differences [16]. Cidlowski’s group also observed that dexamethasone antagonizes estrogen action, suggesting that attempting to counteract stress-induced hypercortisolism by giving exogenous estrogen will not achieve that goal [17].

In conclusion, cognitive behavior therapy lowers cortisol and restores reproductive function, improves metabolic variables without weight change, and has the potential to restore autonomy and sense of social control which may reduce stress sensitivity. The effect size of CBT accrues indefinitely and may mitigate the impact of poor socioeconomic circumstances (social determinants of health). CBT has the potential to improve maternal and child health in the face of ongoing stress and to modify appetite and food preference and of course CBT may be initiated concomitantly with other interventions.

References

- [1] Berga SL. *Stress and reproduction: a tale of false dichotomy?* Endocrinology 2008 Mar;149(3):867-8.
- [2] Loucks AB, Thurma JR. *Luteinizing hormone pulsatility is disrupted at a threshold of energy availability in regularly menstruating women.* J Clin Endocrinol Metab 2003 Jan;88(1):297-311.
- [3] Forsum E, Löf M. *Energy metabolism during human pregnancy.* Annu Rev Nutr 2007;27:277-92.
- [4] Berga SL, Mortola JF, Girton L, Suh B, Laughlin G, Pham P, Yen SS. *Neuroendocrine aberrations in women with functional hypothalamic amenorrhea.* J Clin Endocrinol Metab 1989 Feb;68(2):301-8.
- [5] Reindollar RH, Novak M, Tho SP, McDonough PG. *Adult-onset amenorrhea: a study of 262 patients.* Am J Obstet Gynecol 1986 Sep;155(3):531-43.
- [6] Caronia LM, Martin C, Welt CK, Sykiotis GP, Quinton R, Thambundit A et al. *A genetic basis for functional hypothalamic amenorrhea.* N Engl J Med 2011 Jan 20;364(3):215-25.
- [7] Berga SL, Loucks-Daniels TL, Adler LJ, Chrousos GP, Cameron JL, Matthews KA, Marcus MD. *Cerebrospinal fluid levels of corticotropin-releasing hormone in women with functional hypothalamic amenorrhea.* Am J Obstet Gynecol 2000 Apr;182(4):776-81.
- [8] Brundu B, Loucks TL, Adler LJ, Cameron JL, Berga SL. *Increased cortisol in the cerebrospinal fluid of women with functional hypothalamic amenorrhea.* J Clin Endocrinol Metab 2006 Apr;91(4):1561-5.
- [9] Williams N, Berga SL, Cameron JL. *Synergism between psychosocial and metabolic stressors: impact on reproductive function in cynomolgus monkeys.* Am J Physiol Endocrinol Metab 2007 Jul;293(1):E270-6.
- [10] Loucks TL, Dube J, Laychak K, Robertson RJ, Berga SL. *Metabolic and endocrine responses to submaximal exercise challenge in women with functional hypothalamic amenorrhea.* Abstract #605 at the 51st Annual Meeting of the Society for Gynecological Investigation, Houston, TX, March 24-27, 2003.
- [11] Michopoulos V, Embree M, Reding K, Sanchez MM, Toufexis D, Votaw JR et al. *CRH receptor antagonism reverses the effect of social subordination upon central GABAA receptor binding in estradiol-treated ovariectomized female rhesus monkeys.* Neuroscience 2013 Oct 10;250:300-8.

- [12] Berga SL, Daniels TL, Hoffman GE, Kalro BN, Hill LM, McCarty KS *et al.* Chapter 2: Secondary Amenorrhea. In: *Atlas of Clinical Gynecology*, Stenchever M, series editor, Mishell D, volume editor, Reproductive Endocrinology, Current Medicine, Inc, Philadelphia, PA 1999, 3: 2.2-2.16.
- [13] Marcus MD, Loucks TL, Berga SL. *Psychological correlates of functional hypothalamic amenorrhea*. Fertil Steril 2001 Aug;76(2):310-6.
- [14] Berga SL, Marcus MD, Loucks TL, Hlastala S, Ringham R, Krohn MA. *Recovery of ovarian activity in women with functional hypothalamic amenorrhea who were treated with cognitive behavior therapy*. Fertil Steril 2003 Oct;80(4):976-81.
- [15] Michopoulos V, Mancini F, Loucks TL, Berga SL. *Neuroendocrine recovery initiated by cognitive behavioral therapy in women with functional hypothalamic amenorrhea: a randomized, controlled trial*. Fertil Steril 2013 Jun;99(7):2084-91.e1.
- [16] Duma D, Collins JB, Chou JW, Cidlowski JA. *Sexually dimorphic actions of glucocorticoids provide a link to inflammatory diseases with gender differences in prevalence*. Sci Signal 2010 Oct 12;3(143):ra74.
- [17] Whirledge S, Cidlowski JA. *A role for glucocorticoids in stress-impaired reproduction: beyond the hypothalamus and pituitary*. Endocrinology 2013 Dec;154(12):4450-68.



Stress and PCOS

Bart C.J.M. Fauser

Department Reproductive Medicine and Gynecology, University Medical Center, Utrecht, The Netherlands

Women with PCOS (polycystic ovary syndrome) exhibit significantly more emotional distress compared with women without PCOS. The cause of emotional distress could only partly be explained by methodological or clinical features. Clinicians should be aware of the emotional aspects of PCOS, discuss these patients and refer for appropriate support where necessary and in accordance with patient preference [1].

PCOS is still hard to understand completely, in fact it is a very heterogeneous condition, difficult to study for the lack of animal models due to species differences. In addition to that, despite the large number of investigators with strong opinion, the convincing data are just a few.

There is a multitude of circulating markers of oxidative stress in polycystic ovary syndrome, as documented by the meta-analysis published by Murri *et al.*: among promoters and by-products of oxidative stress we find homocysteine, ADMA and malondialdehyde increased as well as the antioxidant glutathione is reduced (• [Table 1](#)) [2].

It's already known that PCOS is associated to reproductive disorders (irregular cycles, acne, hirsutism, infertility) and also to metabolic phenomena (obesity, insulin resistance, hypertension, dyslipidemia, metabolic syndrome), but long term studies done so far had failed in strongly demonstrate that there is an increased risk of cardiovascular diseases.

The heart of the controversy is the PCOS diagnosis. Rotterdam Criteria are still true, but it's important to have a different approach in dealing with a pre-menopausal patient and a peri-menopausal one: the ultrasound criteria will not match in the second case and furthermore it is an irrelevant aspect to investigate, thus we have to be flexible and not dogmatic about it.

In 2012 there was a wise committee of NIH on PCOS and came out an independent panel with a few recommendations: firstly it is time to change the name PCOS,

• **Table 1.** Summary of meta-analysis of circulating markers of oxidative stress in PCOS

Marker	Action	Changes in PCOS
<i>Promoters and byproducts of oxidative stress</i>		
Homocysteine	Promotes reactive species	↑
ADMA	Promotes reactive species	↑
Malondialdehyde	End-product of lipid peroxidation	↑
Nitric oxide	Promotes reactive nitrogen species	↔
<i>Antioxidants</i>		
Glutathione	Detoxifies hydrogen peroxide and lipid peroxides, prevents protein from oxidation	↓
Paraoxonase-I	Prevents oxidation of lipoproteins by reactive species	↓
SOD	Converts superoxide anions to hydrogen peroxide and molecular oxygen	↑
Glutathione peroxidase	Detoxifies hydrogen peroxide, peroxy nitrates and lipid peroxides	↔
TAC	Prevents oxidation and detoxifies oxidants	↔

↓, decreased; ↑, increased; ↔, unchanged; ADMA, asymmetric dimethylarginine; SOD, superoxide dismutase activity; TAC, total antioxidant capacity.

Source: Murri *et al.*, 2013 [2].

which is also hard to pronounce! Secondly we still must consider the broad, inclusive Rotterdam Criteria while improving methods to assess androgen excess, ovulatory dysfunction and PCO morphology.

Another point is the involvement of “consumers” in guideline development, which could let us look this condition from a direct point of view. Last but not least, it is mandatory to establish multi-disciplinary programs to improve public awareness and management: endocrinologists and gynaecologists have different approaches in diagnosis and therapy and this can frequently lead to a poor level of care (• **Table 2**) [3].

PCOS is still a very common condition, as remarked by the research of March *et al.* on prevalence of this affection in a community sample assessed under contrasting diagnostic criteria (NIH, Rotterdam and AES). It is a retrospective cohort study that involved 728 women (born since 1973 till 1975) from a single hospital.

The estimate prevalence found was respectively 8.7 according to NIH criteria, 11.9 to Rotterdam Criteria (17.8% imputed) and 10.2 to AES (12.0% imputed). In conclusion, Rotterdam and AES prevalence estimated up twice compared to NIH [4].

• **Table 2.** Investigations requested respectively by the two specialists for the index case

	Endo (%) n = 138	Gyn (%) n = 172	p-value
LH, FSH	91	94	0.442
Oestradiol	64	56	0.188
Progesterone	36	37	0.757
Testosterone	99	92	0.010
SHBG	87	81	0.037
17-OH progesterone	70	46	<0.001
DHEAS	80	58	<0.001
Androstenedione	45	35	0.72
Prolactin	79	74	0.346
Urinary free cortisol	17	6	0.007
Any glucose assessment	89	76	0.02
Fasting glucose	65	28	<0.001
OGTT	25	45	<0.001
Insulin	50	41	0.113
Fasting lipids	67	34	<0.001
Ovarian ultrasound	44	91	<0.001
Endometrial ultrasound	9	64	<0.001
D&C	1	4	0.08
Hysteroscopy	1	6	0.026
Laparoscopy	1	8	0.013

Source: Cussons *et al.*, 2005 [3].

PCOS is often linked to obesity, but sometimes we have severe forms of PCOS in lean women and on the other hand obese women with normal menstrual cycles. Certainly there is a genetic predisposition and obesity on top of this, thus we can assume that with the worldwide increasing of obesity we will certainly have more PCOS diagnosis.

An interesting meta-analysis of 35 selected studies, confronting PCOS patients *versus* controls matched for weight, shows that, considering impaired glucose tolerance, the Odds Ratio (with a confidential interval of 95%) was 2.56 (1.45-4.51), while considering diabetes type II was 4.06 (1.98-8.36) and for metabolic syndrome 2.12 (1.11-4.05) [5]. So it's not obesity that give rise to this problem, but we still don't understand why that is.

• **Table 3.** Overview classical PCOS follow-up studies

Author	Patients	Intermediate outcomes	CVD outcomes
Dahlgren 1992	n=35, 22-31 yrs follow-up	More diabetes More hypertension	
Pierpoint 1998	n=986, diagnosed between 1930-1979		SMR 0.9 (95% CI 0.7-1.2)
Wild 2000	n=240, diagnosed before 1979 (720 controls)	More cerebral disease More diabetes	Similar CHD morbidity and mortality
Elting 2001	n=346, 2-32 yrs follow-up	More diabetes More hypertension	

CVD: cardiovascular disease; SMR: standardized mortality rate; CHD: coronary heart disease.

What is clear by literature it is that hyperandrogenemia is tightly linked to the PCOS and to the metabolic dysfunction, but it has also demonstrated that the chance to have a baby is mostly related to the body weight: in fact, having a BMI over 35 kg/m² reduces chances of 1/3. There is 75-80% cumulative chance of pregnancy rate resulting in singleton live birth with ovulation induction [6]. Therefore with sudden meta-analysis it has been seen that gestational diabetes, pre-eclampsia and preterm birth are distinctly increased in women with PCOS.

We know that the fetal development is crucial for future health of the children even more than the health situation of the woman before she gets pregnant. That is the reason why now we much more focus on pregnancy complication and children outcomes.

Talking about PCOS, is it genetically determined or the children outcomes are related to the fetal conditions per se? Of course probably it is a combination of a multitude of factors. What we have to do is to phenotype the patient, follow the pregnancy, check birth condition, follow childhood and consequently adult life.

About the cardiovascular condition of PCOS women, we know that the intima-media thickness, the gold standard for cardiovascular disease risk assessment, is clearly abnormal in PCOS women.

Nonetheless if we look at follow-up studies we can see that PCOS patients have more intermediate outcomes (diabetes, hypertension, cerebral disease), but in terms of true cardiovascular disease outcomes there is no significant difference (• **Table 3**).

As it can be seen in • **Table 4**, after all these years of studies and data, there is still not a consensus on the recommendations to follow in glucose intolerance screening in PCOS, suggesting that probably there is still a long work to do.

• **Table 4.** Organization recommendations for glucose intolerance screening in PCOS

Organization	Recommendation
Am Soc Clin Endocr	Glucose for all, OGTT considered in obese women
Am Coll Ob Gyn	Fasting glucose, OGTT for all
Am Diab Assoc	DM screening under 45 yrs in overweight and additional risk factors (like PCOS) - fasting glucose (OGTT considered)
ASRM	Screening for MS in obese PCOS (including OGTT)
AES	OGTT for all

References

- [1] Veltman-Verhulst SM, Boivin J, Eijkemans MJ, Fauser BJ. *Emotional distress is a common risk in women with polycystic ovary syndrome: a systematic review and meta-analysis of 28 studies.* Hum Reprod Update 2012 Nov-Dec;18(6):638-51.
- [2] Murri M, Luque-Ramírez M, Insenser M, Ojeda-Ojeda M, Escobar-Morreale HF. *Circulating markers of oxidative stress and polycystic ovary syndrome (PCOS): a systematic review and meta-analysis.* Hum Reprod Update 2013 May-Jun;19(3):268-88.
- [3] Cussons AJ, Stuckey BG, Walsh JP, Burke V, Norman RJ. *Polycystic ovarian syndrome: marked differences between endocrinologists and gynaecologists in diagnosis and management.* Clin Endocrinol (Oxf), 2005 Mar;62(3):289-95.
- [4] March WA, Moore VM, Willson KJ, Phillips DI, Norman RJ, Davies MJ. *The prevalence of polycystic ovary syndrome in a community sample assessed under contrasting diagnostic criteria.* Hum Reprod 2010 Feb;25(2):544-51.
- [5] Moran LJ, Misso ML, Wild RA, Norman RJ. *Impaired glucose tolerance, type 2 diabetes and metabolic syndrome in polycystic ovary syndrome: a systematic review and meta-analysis.* Hum Reprod Update 2010 Jul-Aug;16(4):347-63.
- [6] Veltman-Verhulst SM, Fauser BC, Eijkemans MJ. *High singleton live birth rate confirmed after ovulation induction in women with anovulatory polycystic ovary syndrome: validation of a prediction model for clinical practice.* Fertil Steril 2012 Sep;98(3):761-768.e1.

Stress, endometrium, and implantation

Basil C. Tarlatzis¹, Antonis Kalpatsanidis¹, Antonis Makrigiannakis²

¹ Unit for Human Reproduction, 1st Department of Obstetrics & Gynecology, Aristotle University of Thessaloniki, Greece

² Department of Obstetrics & Gynecology, School of Medicine, University of Crete, Crete, Greece

Epidemiological and experimental studies suggest that environmental events acting on the developing embryo in utero are crucial determinants for disorders later in life [1], a phenomenon known as “fetal programming”.

Prenatal maternal may lead to preterm birth, low birth weight [2], life-long dysregulation of the HPA axis [3], metabolic and neurodevelopmental abnormalities, insulin resistance, type II diabetes, cardiovascular disease and behavioural problems [4]. The main central regulators of the HPA axis are CRH and AVP (arginine-vasopressin): both produced by the parvicellular neurons (hypothalamus) and both synergically stimulate pituitary ACTH secretion and subsequently glucocorticoid secretion by the adrenal cortex.

Several stress effects on the female reproductive system have been described: inhibition of GnRH secretion, inhibition of LH secretion, inhibition of ovarian estrogen and progesterone biosynthesis and inhibition of estradiol-stimulated uterine growth.

CRH is a 41-amino acid neuropeptide, responsible for endocrine, autonomic, immunological and behavioural responses of mammalian organisms to stress. It is mainly synthesized in the hypothalamus and its major role is the regulation of the HPA axis. CRH and its receptors are also found in many extra-hypothalamic sites of the central nervous system, playing a major coordinative role in the stress response [5]. CRH exerts its effects by binding to plasma membrane receptors that are coupled to Gs protein and adenylate cyclase. CRH receptor genes are:

- CRH- R1 in mammals;
- CRH-R2 in mammals;
- CRH-R3 catfish.

However, CRH and its receptors have also been identified in the female and male reproductive system, and there is an ovarian CRH, an endometrial CRH and a pla-

cental CRH. CRH promote decidualization, blastocyst implantation, adhesion and invasion, maternal tolerance, regulation of fetoplacental circulation and induction of fetal adrenal steroidogenesis. A stressful condition may lead to failed or abnormal implantation, shallow trophoblast invasion, deficient remodelling of spiral arteries, preeclampsia, IUGR and preterm or delayed labor [6].

CRH participates in various reproductive functions with an inflammatory component that serves as an autocrine and paracrine modulator: ovarian CRH, uterine CRH and placental CRH.

- Ovarian CRH:
 - no detectable CRH in oocytes from primordial follicles;
 - abundant expression of the CRH and CRH-R1 genes in mature follicles;
 - anti-reproductive actions (inhibitory effect on ovarian steroidogenesis) [7-9];
 - localized in the thecal cells surrounding the ovarian follicles, in luteinized cells of the stroma and in the cytoplasm of the ovum.
- Placental CRH:
 - large amounts of CRH mostly during the latter half of pregnancy;
 - synthesis of CRH increases with advancing gestation;
 - secretion is stimulated by glucocorticoids, inflammatory cytokines, and anoxic conditions, including the stress of preeclampsia or eclampsia;
 - enters the fetus and stimulates the production of dehydroepiandrosterone;
 - high concentration in maternal blood, fetal blood and in the amniotic fluid;
 - participates in the maintenance of vascular tone. Consequently, in pre-eclamptic and growth-restricted pregnancies we find increased CRH and decreased placental CRH-R1 [10].
- Intrauterine CRH:
 - fundamental role in the mechanisms responsible for embryo implantation and maintenance of human pregnancy;
 - mainly produced in epithelial cells;
 - mainly found in stromal cells (when differentiated to decidual cells);
 - CRH-R1 is present in both epithelial and stromal cells.

The major function of the Fas-FasL interaction is the induction of apoptosis in activated cells carrying Fas [11], for example in cells located at the interface between the fetal placenta and maternal endometrium. CRH induces the expression of the FasL protein in human macrophages, empowering their ability to induce apoptosis [12]. It should be noted that mice with missense or inactivating mutations of FasL gene (gld) can reproduce, suggesting that trophoblast FasL expression is not obligatory for maternal immune tolerance. Thus, in the absence of a functional Fas-FasL system, other mechanisms supporting maternal immune tolerance are sufficient to prevent total pregnancy failure [13].

The trophoblast is the first tissue to differentiate in the mammalian conceptus and its normal development is important for implantation and further survival of the embryo:

- CRH controls proper trophoblast invasion, by regulating CEACAM1 expression (the effect is mediated by CRH-R1);
- CRH causes the degranulation of mast cells and the release of histamine and several inflammatory cytokines, including TNF- α , IL-6;
- involves down-regulation of the synthesis of the carcinoembryonic antigen-related cell adhesion molecule 1 (CEACAM1) by extra villous trophoblast cells. CEACAM1 is a member of the carcinoembryonic antigen (CEA) family and the immunoglobulin superfamily, which is expressed in the normal human placenta with a specific localization in the extra villous trophoblast cell.

Increased levels of intrauterine CRH, and UCN1 lead to abortion, through the CRH-R1 induction of the complex Fas-FasL in embryo-maternal interface (• **Figure 1**) [14].

- **Figure 1.** CRH & spontaneous miscarriages

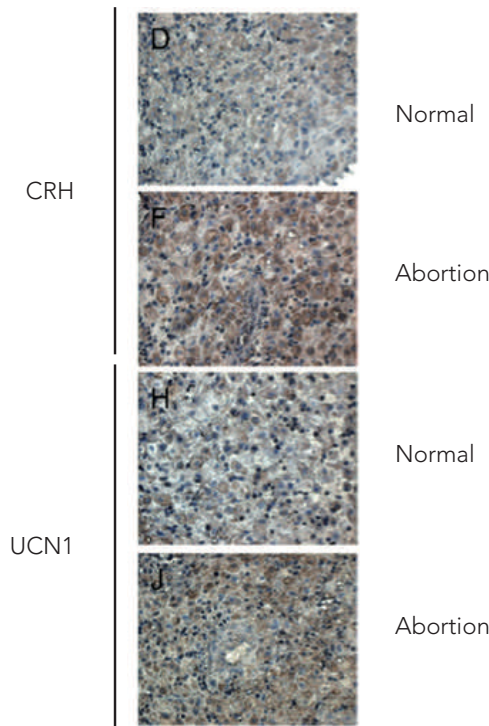

Source: Minas *et al.*, 2007 [14].

Abortion is associated with increased expression of FasL in decidual leukocytes and apoptosis of extra villous trophoblast cells: a role for CRH and urocortin.

Abortive deciduas contain leukocytes that are positive for FasL and extra villous trophoblasts (EVTs), showing increased expression of Fas and increased rates of apoptosis. CRH and UCN were elevated in placental material obtained from abortions.

This observation was further supported by experiments in rats using antalarmin, a non-peptidic CRH-R1 specific antagonist. Administration of antalarmin to early pregnant rats (days 1-6 of pregnancy) resulted in a 70% reduction in the number of implantation sites. However, antalarmin did not completely abolish nidation. This was compatible with the observation that CRH- and CRH-R1-deficient mice are not entirely sterile [15, 16].

Hormonal and cytokine factors act locally at the maternal-fetal interface during the early phase of blastocyst implantation. CRH produced locally by EVT and decidual cells acts through CRHR1 to stimulate FasL synthesis and to potentiate the ability of these cells to cause apoptosis of activated maternal T cells (Fas receptor positive). CRH, LIF, IL-11, CSF-1, IL-6 and IL-1 produced by the endometrial epithelium participate in the regulation of decidual function and placental growth (right-hand side of the diagram). HCG produced by the syncytiotrophoblast acts at the stroma to promote decidualization, as well as at the glandular and luminal epithelium to induce glycodeclin secretion and epithelial plaque reaction, respectively (• **Figure 2**) [17].

The effect of endometrial-derived LIF and CSF-1 (middle of the diagram) in mammalian blastocysts is still a matter of debate.

In conclusion, CRH participates in the nidation of the fertilized oocyte by inhibiting local maternal immune response to the implanted embryo. CRH has a fundamental role in the mechanisms responsible for embryo implantation and maintenance of human pregnancy. Stress in-utero, as this is depicted by CRH-involved pathophysiology, may affect implantation, early pregnancy, parturition, and human development. Abnormalities of decidual, trophoblast and placental CRH have been implicated in several common disease processes of pregnancy, including spontaneous abortions, preeclampsia and intrauterine growth restriction, while increased ovarian CRH concentrations might be related to premature ovarian failure.

However, a fundamental question that remains to be answered is whether the elevated concentrations in CRH are the cause of preterm labor and/or fetal growth restriction and/or preeclampsia or the consequence of an underlying pathophysiology.

- **Figure 2.** Hormonal and cytokine factors acting locally at the maternal-fetal interface during the early phase of blastocyst implantation

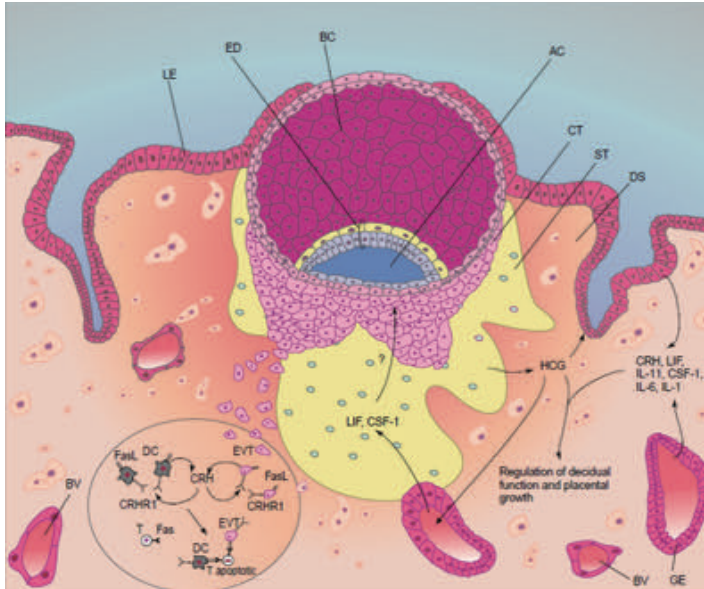

AC, amniotic cavity; BC, blastocyst cavity; BV, blood vessel; CRH, corticotropin-releasing hormone; CRHR1, CRH receptor type 1; CT, cytotrophoblast; DC, decidual cell; DS, decidualized stroma; ED, embryonic disk; EVT, extravillous trophoblast; Fas, Fas receptor; FasL, Fas ligand; GE, glandular epithelium; HCG, human chorionic gonadotropin; IL, interleukin; LE, luminal epithelium; LIF, leukemia inhibitory factor; ST, syncytiotrophoblast; T, T lymphocyte).

Source: Makrigiannakis et al., 2006 [17].

References

- [1] Fowden AL, Sibley C, Reik W, Constancia M. *Imprinted genes, placental development and fetal growth*. *Horm Res* 2006;65(Suppl 3):50-8.
- [2] Wadhwa PD. *Psychoneuroendocrine processes in human pregnancy influence fetal development and health*. *Psychoneuroendocrinology* 2005 Sep;30(8):724-43. Epub 2005 Apr 25. Review.
- [3] Merlot E, Couret D, Otten W. *Prenatal stress, fetal imprinting and immunity*. *Brain Behav Immun* 2008 Jan;22(1):42-51. Epub 2007 Aug 22.
- [4] O'Donnell K, O'Connor TG, Glover V. *Prenatal stress and neurodevelopment of the child: focus on the HPA axis and role of the placenta*. *Dev Neurosci* 2009;31(4):285-92.

- [5] Makrigiannakis A, Zoumakis E, Kalantaridou S, Mitsiades N, Margioris A, Chrousos GP, Gravanis A. *Corticotropin-releasing hormone (CRH) and immunotolerance of the fetus*. *Biochem Pharmacol* 2003 Mar 15;65(6):917-21.
- [6] Vrekoussis T, Kalantaridou SN, Mastorakos G, Zoumakis E, Makrigiannakis A, Syrrou M *et al*. *The role of stress in female reproduction and pregnancy: an update*. *Ann N Y Acad Sci* 2010 Sep;1205:69-75.
- [7] Calogero AE, Burrello N, Negri-Cesi P, Papale L, Palumbo MA, Cianci A *et al*. *Effects of corticotropin-releasing hormone on ovarian estrogen production in vitro*. *Endocrinology* 1996 Oct;137(10):4161-6.
- [8] Ghizzoni L, Mastorakos G, Vottero A, Barreca A, Furlini M, Cesarone A *et al*. *Corticotropin-releasing hormone (CRH) inhibits steroid biosynthesis by cultured human granulosa-lutein cells in a CRH and interleukin-1 receptor-mediated fashion*. *Endocrinology* 1997 Nov;138(11):4806-11.
- [9] Dinopoulou V, Partsinevelos GA, Mavrogianni D, Anagnostou E, Drakakis P, Makrigiannakis A *et al*. *The effect of CRH and its inhibitor, antalarmin, on in vitro growth of preantral mouse follicles, early embryo development, and steroidogenesis*. *Endocrinology* 2013 Jan; 154(1):222-31. Epub 2012 Dec 4.
- [10] Kalantaridou SN, Makrigiannakis A, Mastorakos G, Chrousos GP. *Roles of reproductive corticotropin-releasing hormone*. *Ann N Y Acad Sci* 2003 Nov;997:129-35.
- [11] Nagata S. *Fas and Fas ligand: a death factor and its receptor*. *Adv Immunol* 1994;57:129-44.
- [12] Petsas G, Jeschke U, Richter DU, Minas V, Hammer A, Kalantaridou S *et al*. *Aberant expression of corticotropin-releasing hormone in pre-eclampsia induces expression of FasL in maternal macrophages and extravilloustrophoblast apoptosis*. *Mol Hum Reprod* 2012 Nov;18(11):535-45. Epub 2012 Jul 4.
- [13] Makrigiannakis A, Zoumakis E, Kalantaridou S, Coutifaris C, Margioris AN, Coukos G *et al*. *Corticotropin-releasing hormone promotes blastocyst implantation and early maternal tolerance*. *Nat Immunol* 2001 Nov;2(11):1018-24.
- [14] Minas V, Jeschke U, Kalantaridou SN, Richter DU, Reimer T, Mylonas I *et al*. *Abortion is associated with increased expression of FasL in decidual leukocytes and apoptosis of extravilloustrophoblasts: a role for CRH and urocortin*. *Mol Hum Reprod* 2007 Sep;13(9):663-73.
- [15] Psychoyos A. *Uterine receptivity for nidation*. *Ann N Y Acad Sci* 1986;476:36-42.

[16] Muglia L, Jacobson L, Dikkes P, Majzoub JA. *Corticotropin-releasing hormone deficiency reveals major fetal but not adult glucocorticoid need*. *Nature* 1995;373:427-32.

[17] Makrigiannakis A, Minas V, Kalantaridou SN, Nikas G, Chrousos GP. *Hormonal and cytokine regulation of early implantation*. *Trends Endocrinol Metab* 2006 Jul;17(5):178-85. Epub 2006 May 15. Review



Stress and infertility

Anthony Luciano

Obstetrics and Gynecology, University of Connecticut School of Medicine,
Farmington, USA

Stress plays a major role in infertility, not only in terms of adversely affecting the quality of life, but also by making it more difficult for the couples to get pregnant.

Barbara Manning, the founder of the national support group for infertile couples, RESOLVE, describes the stress associated with infertility as a crisis of many dimensions, and although not really appreciated by unaffected couples, the suffering and distress associated with infertility rivals any other physical problem that a person may experience.

Infertility has been ranked as one of the greatest sources of stress in a person's life, comparable to a somatic disease such as cancer [1]. In addition, the stress associated with the treatment of infertility has been ranked second only to the most severe crises, as divorce or death, by women undergoing fertility treatment [2].

Researchers from the University of Michigan exploring the experiences of African-American women coping with infertility have found that many African-American women experience infertility in silence and isolation from friends and family. "Infertility also impaired their sense of self-worth and gender identity". Some women stated that having no biological children "would label you as a failure". "I don't feel like a complete woman" [3].

As with all threatening events, the response to the stress of infertility may be with fight or flight. Some couples respond with fight by aggressively pursuing treatment and procedures, such as "give me the best and the fastest" or with flight, by withdrawal and isolation. Withdrawal and isolation not only may add to the stress but may also become obstacles to the successful management of infertility, such as poor compliance, poor eating habits, poor health and marital discord.

Thus stress reduction is very important in the management of infertility not only to improve quality of life and improve the couple's relationship, but also guide them

toward reaching better informed decision in their therapeutic options, options that need to consider their cultural, religious and financial status.

Although there are several well established stress reduction techniques (according to ASRM recommendations as summarized in • **Table 1**, the most important and most effective way to reduce stress of infertile couples is to teach them the basic facts of infertility. They need to know that approximately 15% of couples suffer the same problem, that it is not their fault (neither his or hers), nor it is a punishment, and that specific causes can usually be found and corrected. The infertility specialist must stress that from the moment we start this pathway together we are a team, working together toward a successful resolution of their infertility which is very likely by using the current reproductive technologies. The goal of stress reduction is to minimize but not eliminate stress. Some stress is needed to stimulate the couple in seeking the management options that may serve the needs of the couple the best. Another key point is that the stress associated with infertility is acute and once the infertility is resolved the stress is usually resolved.

When the cause of infertility is stress and not stress caused by infertility the problem is different and much bigger. The stress is not acute but chronic, it precedes infertility and it is not relieved by infertility. It is associated with somatic and psychosomatic symptoms and diseases: depression, cardiovascular disease, and immune suppression. Women presenting at infertility clinics with stress-associated reproductive dysfunction have significantly higher than average levels of eating disorders, dysfunctional attitudes about eating, and obsessive attributes. Studies suggest that there may be a link between stress-related psychiatric disorders and reproductive dysfunction.

The infertility associated with this kind of chronic stress is usually related to hypothalamic anovulation and amenorrhea, characterized by low serum levels of FSH, LH and E-2, but normal TSH and PRL levels. ACTH and cortisol levels may be also elevated from stress induced elevated CRF. Excess release of CRF suppresses GnRH release from the hypothalamus, leading to hypogonadotropic-hypogonadism [4].

The neuroendocrine scenario of women with stress-related hypothalamic hypogonadism is further complicated by the fact that they often display other neuroendo-

• **Table 1.** Stress reduction techniques

Stress reduction techniques	Supportive counseling
Acupuncture	Common 15% of couples are affected
Aerobic exercise	It is not their fault nor a punishment
Psychotherapy	Causes are usually found and corrected
Guided imagery	We are here to help you succeed
Yoga, meditation	We are now a team with same goal
Message therapy	Success rates are high >90%

crine secretory aberrations including hypercortisolemia and hypothalamic hypothyroidism [5]. These neuroendocrine dysfunctions may have untoward consequences on the course of pregnancy and on fetal neuropsychological development [6].

In men, stress may cause oligo-astheno-azoospermia and subsequent infertility. When fertility is not an issue, hypothalamic hypogonadism presents as decreased libido, diminished muscle mass, or altered hair growth [7].

Li *et al.* [8] examined the relationship between stress and recurrent miscarriage (RM) and the impact of stress on the establishment of pregnancy. 45 patients with unexplained RM were compared to 40 age-matched controls. Stressed status was prospectively measured and compared with Fertility Problem Inventory (FPI), Perceived Stress Scale (PSS), Positive Affect Scale (PAS), Negative Affect Scale (NAS), Peripheral NK cells and Cortisol levels.

RM patients had higher scores on the FPI ($P < 0.05$, adjusted OR 1.02), PSS ($P < 0.05$, adjusted OR 1.13) and Negative Affect scale ($P < 0.05$, adjusted OR 1.12) and lower scores on the Positive Affect scale ($P < 0.05$, adjusted OR 0.89) than fertile controls.

There were no differences in peripheral CD^{dim} NK cells or CD^{bright} NK cells and no differences in serum or salivary cortisol levels nor in cortisol suppression after overnight dexamethasone 1 mg administration.

There was little association between psychological stress measurements and biochemical stress measurements. 31 of the 45 women with RM conceived during the study period. There was no significant difference in the scores of the FPI, both domains on the PANAS and the results of peripheral CD bright NK cells between the two groups.

Of the 31 pregnancies, 21 (67%) delivered and 10 (32.3%) miscarried. The live-birth group had significantly lower scores in the PA scale ($P < 0.05$, adjusted OR 1.17, 95% CI 1.03-1.33) than the miscarriage group, suggesting that patients with subsequent live births had elevated levels of depression compared with those who miscarried again. It is possible that the higher baseline depressive moods in these patients who carried to term might have been improved by the fertility team during treatment resulting in better outcomes. These results suggest that stress is a risk factor of RM. Therefore, in women with RM, moderate stress appears to be associated with improved pregnancy outcome [8].

The focus of managing stress related infertility should be on the treatment of the underlying psychosocial maladaptation as well as on metabolic and behavioral dysfunction. It is fundamental to promote healthy eating habits, encourage healthful lifestyle, dispel maladaptive attitudes regarding body image and implementing behavioral strategies to promote health and reduce stress.

“Behavioral and psychological interventions that address problematic behaviors and attitudes have the potential to permit resumption of full ovarian function along with recovery of the adrenal, thyroidal, and other neuroendocrine aberrations. Full endocrine recovery potentially offers better individual, maternal, and child health” [9].

References

- [1] Domar AD, Zuttermeister PC, Friedman R. *The psychological impact of infertility: a comparison with patients with other medical conditions*. J Psychosom Obstet Gynaecol 1993;14 Suppl:45-52.
- [2] Freeman EW, Boxer AS, Rickels K, Tureck R, Mastroianni L Jr. *Psychological evaluation and support in a program of in vitro fertilization and embryo transfer*. Fertil Steril 1985 Jan;43(1):48-53.
- [3] Ceballo R, Graham ET, Hart J. *Silent and Infertile: An intersectional analysis of the experiences of socioeconomically diverse african american women with infertility*. Psychology of Women Quarterly 2015, April 27.
- [4] Petraglia F, Sutton S, Vale W, Plotsky P. *Corticotropin-releasing factor decreases plasma luteinizing hormone levels in female rats by inhibiting gonadotropin-releasing hormone release into hypophysial-portal circulation*. Endocrinology 1987;120:1083-8.
- [5] Berga SL, Daniels TL, Giles DE. *Women with functional hypothalamic amenorrhea but not other forms of anovulation display amplified cortisol concentrations*. Fertil Steril 1997;67:1024-30.
- [6] Morreale de Escobar G, Obregon MJ, Escobar del Rey F. *Is neuropsychological development related to maternal hypothyroidism or to maternal hypothyroxinemia?* J Clin Endocrinol Metab 2000;85:3975-87.
- [7] Harrison KL, Callan VJ, Hennesey JF. *Stress and semen quality in an in vitro fertilization program*. Fertil Steril 1987;48:633-6.
- [8] Li W, Newell-Price J, Jones GL, Ledger WL, Li TC. *Relationship between psychological stress and recurrent miscarriage*. Reprod Biomed Online 2012;25:180-9.
- [9] Berga SL, Loucks TL. *Use of cognitive behavior therapy for functional hypothalamic amenorrhea*. Ann N Y Acad Sci 2006;1092:114-29.

Stress and ART

Antonio Pellicer, Daniela Galliano

Instituto Valenciano de Infertilidad (IVI), Rome, Italy

Maternal age at delivery is one of the main topics talking about fertility, as we can see in statistics from the Eurostat of 2009, showed in • **Figure 1**. In all the selected countries, the percentage of women who get pregnant aged 35 and higher is increased since 1980 [1].

The main consequences of age on fertile women are aneuploidies. So, to discuss the effects of age we have to understand what age induces in any cell of the body, including the oocytes. The cartoon in • **Figure 2** shows the nine hallmarks of aging: from genetic instability, to telomere shortening, epigenetic alterations, stem cells exhaustion, altered intercellular communication, cellular senescence and mitochondrial dysfunction [2]. This research field is certainly destined to grow in the next years, particularly in reproduction, because it's a real challenge. We know that treating our patients with different drugs doesn't work when they are aged and new approaches are in progress, combining in vitro and in vivo experiments.

In the last months a lot of papers came out on treatment with mitochondria, but what we know about this topic is not enough. Mitochondria have a very complex genome, maternally inherited, which is 10 times more prone to DNA damage than the nuclear one. They are the respiratory system of the cell and main vital functions of mitochondria also include redox processes, oxygen sensing, fatty acid oxidation (B-oxidation), calcium homeostasis, cell signalling and programmed cell death.

Copy number of mtDNA increases significantly during oogenesis and then undergoes a rapid decrease during pre-implantation development in larger mammals; in fact we don't find so much activity in mitochondria in early stages of development. At the blastocyst stage, replication in the newly formed embryo is initiated but is restricted to the trophoctoderm. The inner cell mass cells continue to reduce copy number and the "mtDNA set point" is established. Then, when cells differentiate into

● **Figure 1.** Per cent birth rates by women aged 35 and higher, selected countries, 1980-2007

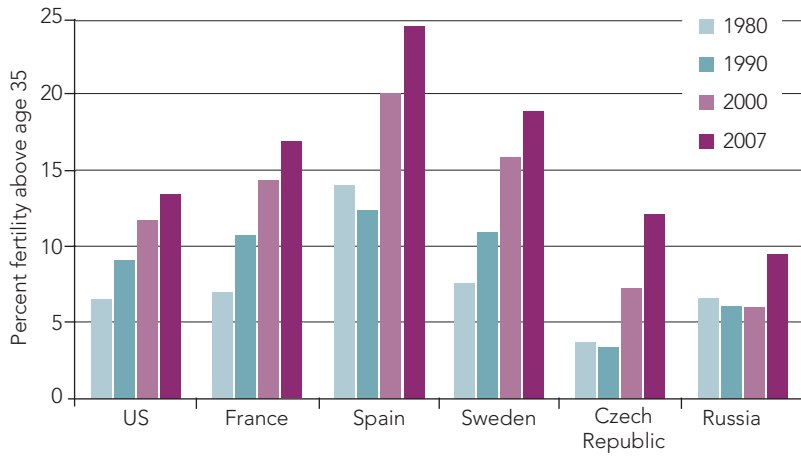

Source: own computations based on data by Eurostat 2009 [1] and national statistical offices.

● **Figure 2.** The nine hallmarks of aging

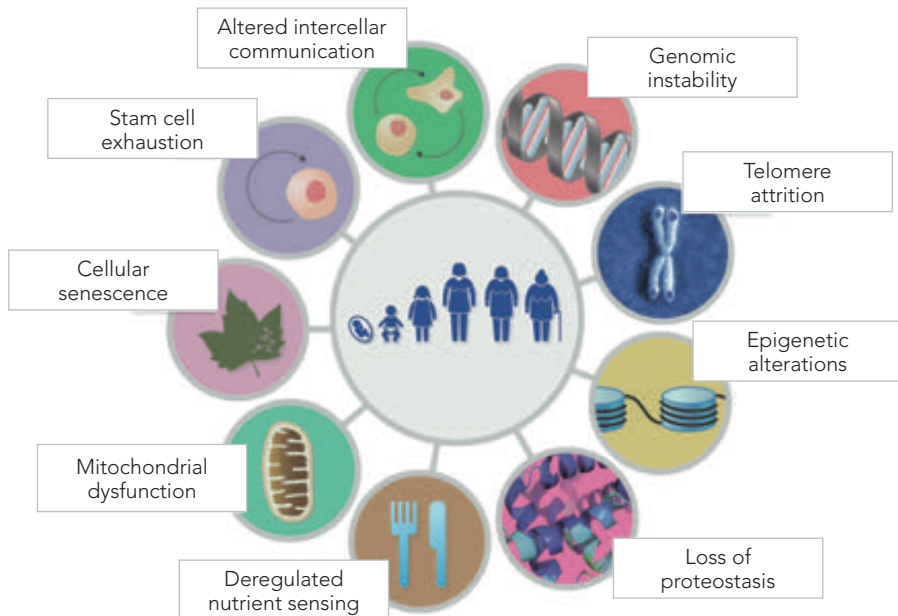

Source: López-Otín et al., 2013 [2].

specialised cell types, they increase copy number to match their needs for ATP in a cell type-specific manner (● **Figure 3**).

If we take a look with electro-microscopy to the mitochondria of the oocytes we can see that they are immature, low-functioning and present little cristae. If we use confocal-microscopy we can observe that only a little amount of mitochondria are polarized and they are confined in oocyte cortex.

In embryos, mitochondria possess only one mtDNA molecule and they are very similar to oocytes ones, due to their relatively low oxygen consumption. On the other hand they look very different from the mitochondria of metabolically active cells found in adult tissues. Even the inhibition of mitochondrial DNA replication in mouse embryos does not prevent development until around the time of implantation. In other words, mitochondrial biogenesis is dispensable for early development.

If an embryo is subjected to stress there will be an increased mitochondrial biogenesis to meet the increased energy demands of the cell, as well as mtDNA replication and trascription and ATP production. For exemple a situation of nutritional stress increases AMP/ATP and NAD⁺/NADH ratios, that are sensed by AMPK and Sirt1, respectively, which activate PGC-1 α , a trascription modulator, crucial factor for mitochondria biogenesis. In case of ischemia the situation is exactly the same.

● **Figure 3.** Mitochondrial dynamics in normal development

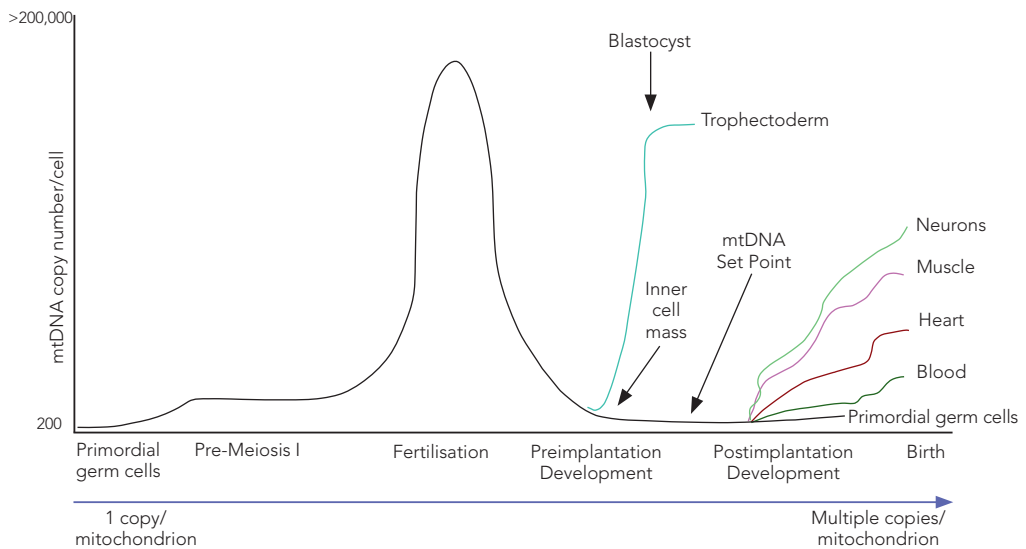

Source: St John, 2012 [3].

● **Figure 4.** Progressive increase of mtDNA in embryo cultures

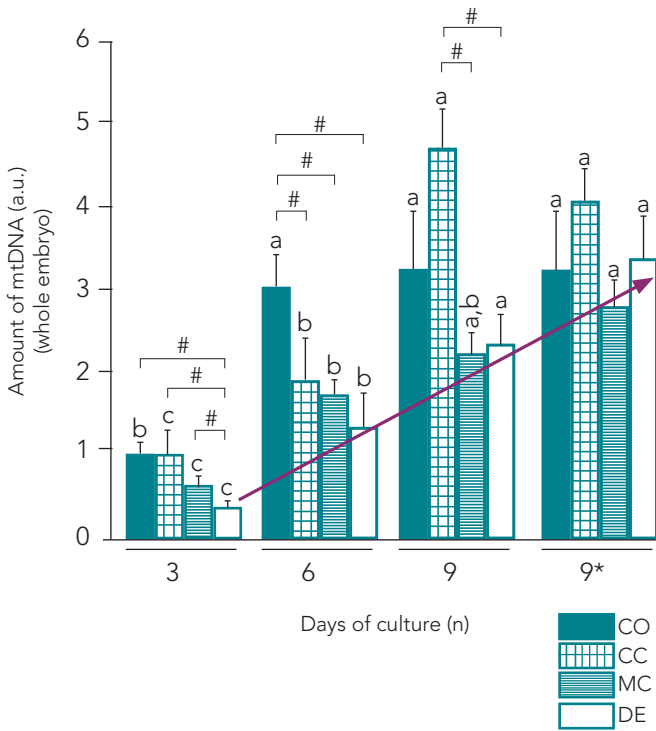

CO group: without centrifugation or micromanipulation; CC group: centrifuged but not micromanipulated; MC group: micromanipulated control; DE group: mitochondrial depleted.

Source: Chiaratti *et al.*, 2010 [4].

The same is true if we manipulate embryos: we will have a progressive increase of mtDNA day after day of embryo cultures (● **Figure 4**) [4].

This is also what happens if we pharmacologically induce energetic stress using 2,4 dinitrophenol (DNP) on trophoblast cells: mtDNA increases and produces morphological mitochondrial changes. After 48 hours, mtDNA content and mitochondrial morphology were analyzed, revealing a higher mitoscore and increased mitochondrial size (● **Figure 5**).

The bottom line is that aging damages nuclear DNA but also the factors involved in mitochondria biogenesis. Aging causes reduction of the number of mitochondria, as well as mitochondria in oocytes that failed to fertilize, leads to morphological changes and increased mtDNA deletions. However, another main problem is that mtDNA mutations start very early in life and they are totally independent from age.

• **Figure 5.** 2,4 dinitrophenol energetic stress induction on trophoblast cells

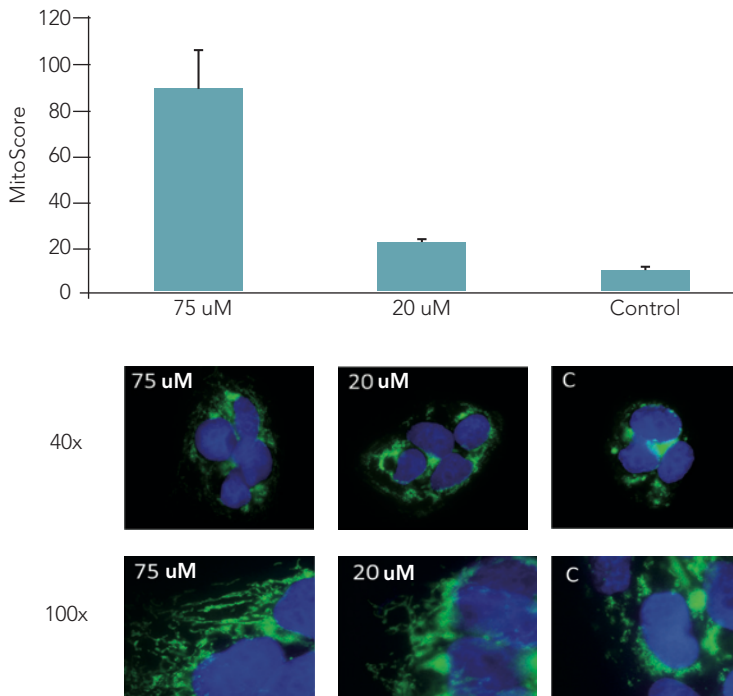

Source: Diez-Juan *et al.*, 2015 [5].

mtDNA as a marker of embryo viability: mitoscore

Clinically, we have the advantage of biopsying the embryos sometimes on day 3, sometimes on day 5 to analyze if there is eu- or aneuploidy, and moreover count the amount of mtDNA. In the last few years, we have isolated and identified mtDNA in biopsied human euploid embryos, using different methods, trying to standardize and compare the amount of mtDNA in these embryos versus normalized mtDNA content. Diez-Juan *et al.* analysed single embryo transfer in 270 patients who underwent pre-implantation genetic screening (205 day-3 blastomer biopsies, and 65 day-5 trophoctoderm biopsies), and 10 patients with double embryo transfer (male-female) [5]. They identified a lower amount of mtDNA in those embryos implanted as compared with the not implanted and that was true for day 3 and day 5. Data distribution showed more variability in mtDNA copy number in non-implanted versus implanted groups both for day-3 embryos and blastocysts. Then they

● **Figure 6.** Mitochondrial DNA threshold values required to predict implantation outcome

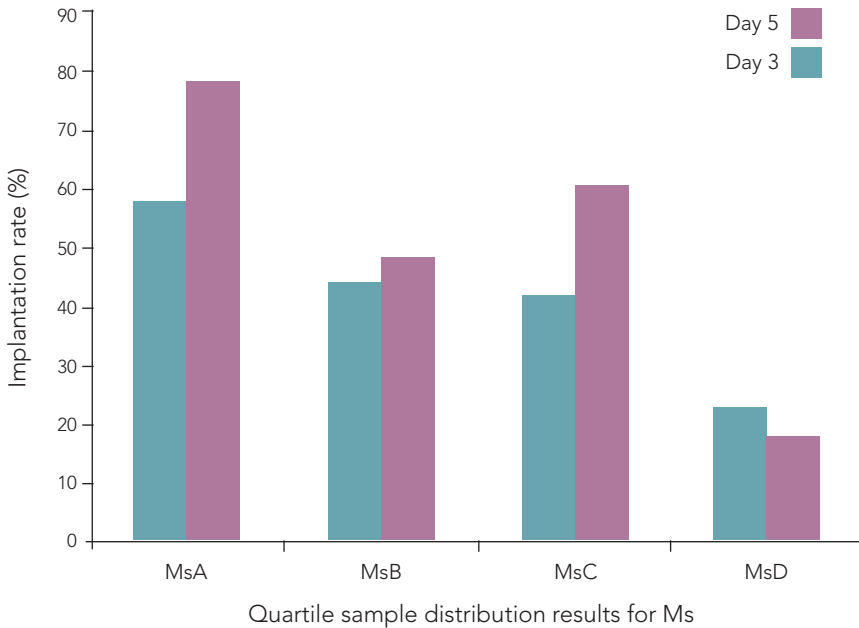

MsA = very low amount of mtDNA; MsD = high amount of mtDNA.

Source: Diez-Juan *et al.*, 2015 [5].

counted the total amount of mtDNA in those embryos and were able to divide them in different quartiles (MsA = very low amount of mtDNA; MsD = high amount of mtDNA). They noticed that the ones with a very low amount of mtDNA had the higher implantation rate on day-3 and on day-5 (● **Figure 6**).

Furthermore, some patients received two embryos, one male and one female, and they observed which one implanted. Six implanted embryos corresponded to those that had the lower relative mtDNA content (#1, #2, #3, #4, #5, #6), in two cases, both embryos had an equivalent amount of mtDNA (#7, #8) and in two cases (#9, #10), the implanted embryo had a higher amount than its sibling (● **Figure 7**).

The rationale behind this is probably that those embryos that implanted had a normal energy reserve, so they didn't need to stimulate mitochondria production, while the ones that didn't achieve implantation had received some kind of stress before. The same results came out from the research group of D. Wells: on average, chromosomally normal blastocysts capable of establishing a clinical pregnancy contained signif-

● **Figure 7.** mtDNA content in pairs of transferred euploid embryos (one male and one female), which resulted in single pregnancies where the gender of the newborn was reported

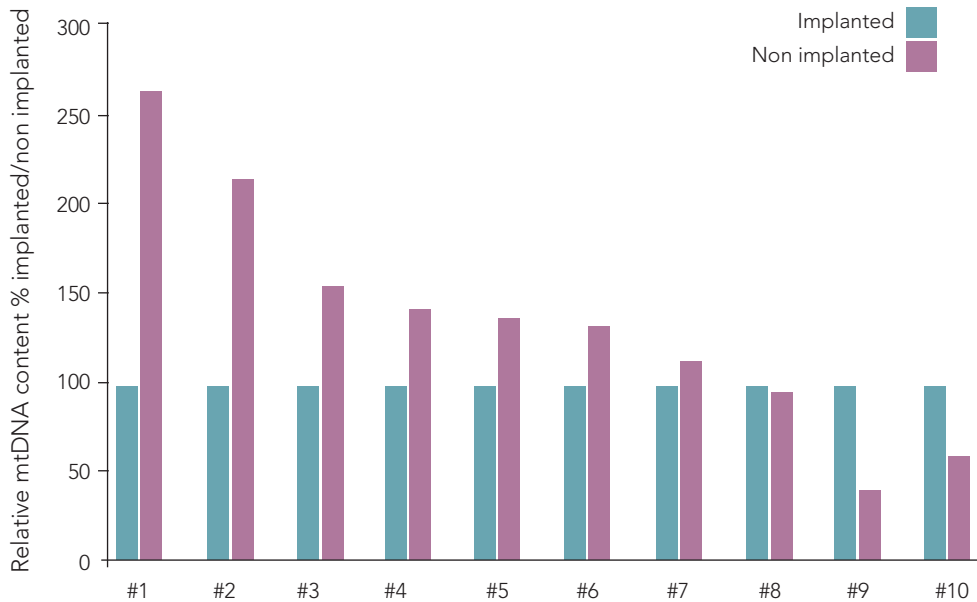

Source: Diez-Juan *et al.*, 2015 [5].

icantly lower levels of mtDNA compared to chromosomally normal blastocysts that failed to do so, and comparing the women age, the average of mtDNA quantity in abnormal embryos, increases according to it. Soon, probably, we will begin to add to our analysis prescription also the stress level of embryos in terms of mtDNA replication.

The further topic could be considering if an oocyte-embryo need functionally active mitochondria for successful implantation. We have to remember that mitochondrial dysfunction is only 1/9 hallmarks of aging, so this is only part of the all topic but methods to treat age-induced stress must consider mitochondrial dysfunction.

A research group is testing a new treatment (unpublished data): the all concept started a few years ago when doctor Tilly at Harvard isolated a small percentage of stem cells in the human ovary that he identified with a very specific homemade antibody (AUGMENT©). Tilly and his group, using this specific antibody, isolated ovarian stem cell mitochondria, then treated the patients with regular ovarian stimulation and at the time of ICSI fertilization they injected inside the mitochondria obtained before.

In Canada, doctor Casper tried AUGMENT© treatment in 34 patients aged 26 to 44 with history of very low outcome in previous stimulation cycles. He compared previous IVF cycles with this cycle and he did a total of 26 replacements with acceptable implantation rate if compared with the previous ones.

In conclusions, mitochondria are not used in early stages of development unless the embryo is under stress. Increased amount of mtDNA in aneuploid embryos is related to poor implantation potential and there are increased amount of mtDNA in non-implanting euploid embryos, thus both may be indicative of increased stress and reduced metabolic fuel. In conclusion, therapies to improve mitochondria biogenesis need to be implemented and properly assessed.

References

- [1] Eurostat 2009.
- [2] López-Otín C, Blasco MA, Partridge L, Serrano M, Kroemer G. *The hallmarks of aging*. Cell. 2013 Jun 6;153(6):1194-217.
- [3] St John JC. *Transmission, inheritance and replication of mitochondrial DNA in mammals: implications for reproductive processes and infertility*. Cell Tissue Res 2012 Sep;349(3):795-808.
- [4] Chiaratti MR, Bressan FF, Ferreira CR, Caetano AR, Smith LC, Vercesi AE, Meirelles FV. *Embryo mitochondrial DNA depletion is reversed during early embryogenesis in cattle*. Biol Reprod 2010 Jan;82(1):76-85.
- [5] Diez-Juan A, Rubio C, Marin C, Martinez S, Al-Asmar N, Riboldi M *et al*. *Mitochondrial DNA content as a viability score in human euploid embryos: less is better*. Fertil Steril 2015 Sep;104(3):534-41.



Stress and preterm birth

John Challis

University of Western Australia, Crawley, WA, Australia and University of Toronto, Toronto, Canada

Preterm birth (PTB) is a global problem: thirteen million babies are born preterm (before 37 weeks gestation) each year and there is an enormous variation in different parts of the world of preterm birth rates. Preterm birth contributes more to under-five deaths than AIDS, malaria or tuberculosis and one million of preterm babies die within the first month. Moreover, survivors experience long-term problems, including cerebral palsy, visual, hearing and neurological impairment [1].

In addition, despite investments and substantial funding from NIH and others, we have not made a lot of progress in reducing the overall preterm birth rate; in fact the percent average has remained nearly the same in the last 20 years.

We have to take in account that rates of preterm birth vary between different populations and ethnic groups. Epidemiologic studies have suggested that the incidence of preterm birth is higher in pregnancies carrying a male fetus compared to the female fetus ones, so we must take fetal sex into account when we assess the risk of preterm labor [2].

Furthermore, we have to take also the gestational age into account, because the ratio of incidence of male/female premature births is much higher earlier in gestation. The proportion of male births declines with increasing gestation, even when time of conception is known and this male excess appears to be strongest for spontaneous preterm births [3].

We have to take also in account ethnic differences when we talk about preterm births: Newnham *et al.* reported that preterm birth rates in women born in China, of South East Asian ethnicity, were among 2.5-4.9% and in woman of the same ethnicity but born in Australia were 8.7%. Caucasian women born in Australia had preterm birth rates of 7.8% and Aboriginals even 14.5%. While these data will require substantiating, there does appear to be some environmental and epigenetic influence on this process [4].

So, preterm birth is a complex endpoint with multi-factorial causes that differs according to gestational age.

For example stress, uterine over-distension and bleeding have been demonstrated to be important causes of late preterm birth occurring from 32 to 36 weeks of gestation. In contrast, cervical insufficiency, and intrauterine infection appear to be the most important causes of early preterm birth prior to 28 weeks of gestation. Unfortunately, for epidemiologic purposes, all preterm births have usually been lumped together as a single endpoint, regardless of etiology. This has led to a finding of largely unsuccessful intervention strategies for the treatment of preterm labor. Clearly PTB is a syndrome that should benefit from a precision medicine approach to diagnosis and treatment.

In reality, each pathway to preterm birth, as depicted in **Figure 1**, is characterized by its own biochemistry and physiology that ultimately leads to decidual and fetal membranes activation, prostaglandin and matrix metalloproteinase production, uterine contractility, rupture of membranes and preterm birth. This means that there are different potential treatments that can be used in the management of preterm births, providing the cause in individual patients is understood.

To link together the stress pathways to the nutritional pathways we have to talk about the origins of glucocorticoids (GC), in particular fetal GC, in pregnancy: there is a rise in fetal GC in late gestation as part of the normal fetal HPA maturational process, but during maternal stress or undernutrition the maternal GC cross the placenta into the fetus. Maternal undernutrition leads to “fetal undernutrition” and hypoxia, and may be caused by reduced uterine or umbilical blood flow, by placental insufficiency or by high altitude. Consequently, collectively, there will be an upregulation of fetal adrenocortical activity and increased fetal GC [5].

In a collaborative study with colleagues in Auckland and Manchester we found that periconceptional undernutrition in sheep accelerated fetal hypothalamic-pituitary-adrenal (HPA) axis activation, resulting in increased fetal adrenocorticotrophic hormone and cortisol release and preterm birth in a high proportion of animals [6]. We found that periconceptional undernutrition resulted in reductions of placental 11 β -hydroxysteroid dehydrogenase2 (11 β -HSD2) isozyme activity and an increased cortisol: cortisone ratio in the fetal circulation at day 50, 85 and 120 of pregnancy. In other studies we had shown that giving very small amounts of GC to the fetus by administration of synthetic GC to the mother in the early stages of gestation, resulted in programming and precocious activation of the HPA axis leading to enhanced responsiveness in the later part of gestation [7].

Looking at the activation of the hypothalamic glucocorticoid receptors (GR) in term twin fetuses compared to singletons, it can be seen that GR promoter methylation is reduced in underfed singletons, but values in twins, even in control pregnancies are already reduced. The hypothalamic GR mRNA expression increases in underfed singletons and this response is preserved (programmed) into adult life. Hence, both twinning and periconceptional maternal undernutrition induce specific epigenetic

• **Figure 1.** Pathways to preterm birth

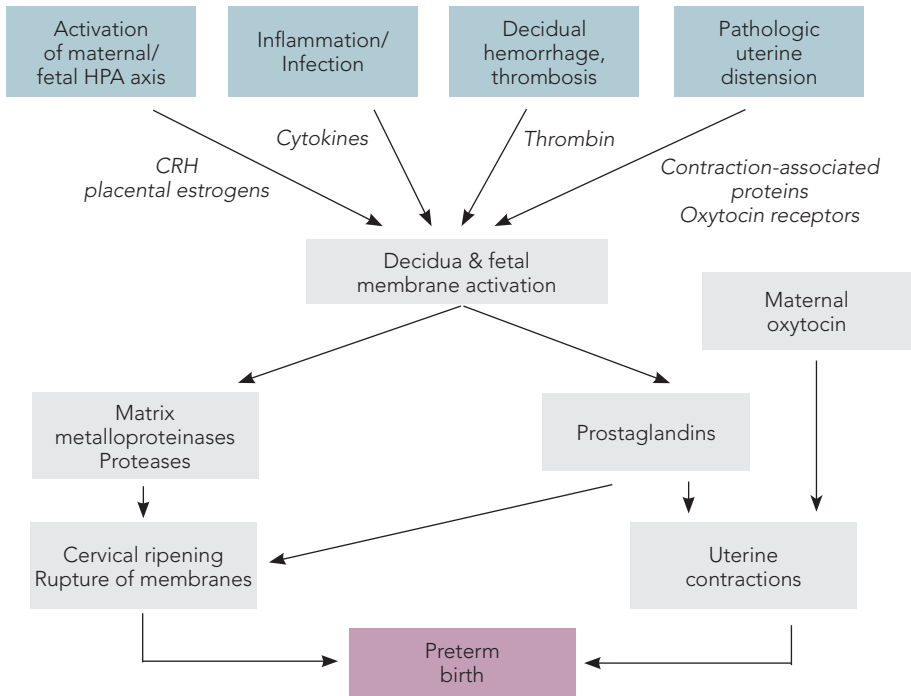

Source: modified from Lockwood, Gravett et al.

modifications in the fetal hypothalamic pathways regulating energy balance. This suggests that twins undergo a nutritional programming event leading to altered physiology of the hypothalamic pathways [8].

During pregnancy there are really three HPA axis: the mother, the placenta and the fetus. In • **Figure 2** are shown the stress hormones with their interactions and consequences in the mother, the placenta and the fetus.

Studies in animals had shown clearly that maternal GC administration resulted in a reduction in fetal and newborn weights. In a collaborative study led by Thorsten Braun in Berlin we asked whether maternal glucocorticoid treatment affected fetal birth weight in women. In • **Figure 3** are shown results of a retrospective study on 44,000 women at the Charite Hospital. Grey bars represent birth weight of neonates who had not received betamethasone. Red bars represent birth weights of neonates who received betamethasone between 22 and 35 weeks. Starting from 32 weeks of gestation, fetuses and neonates of mothers treated with betamethasone had a significant decrease in birth weight compared to controls.

• **Figure 2.** Stress hormones in the human placenta

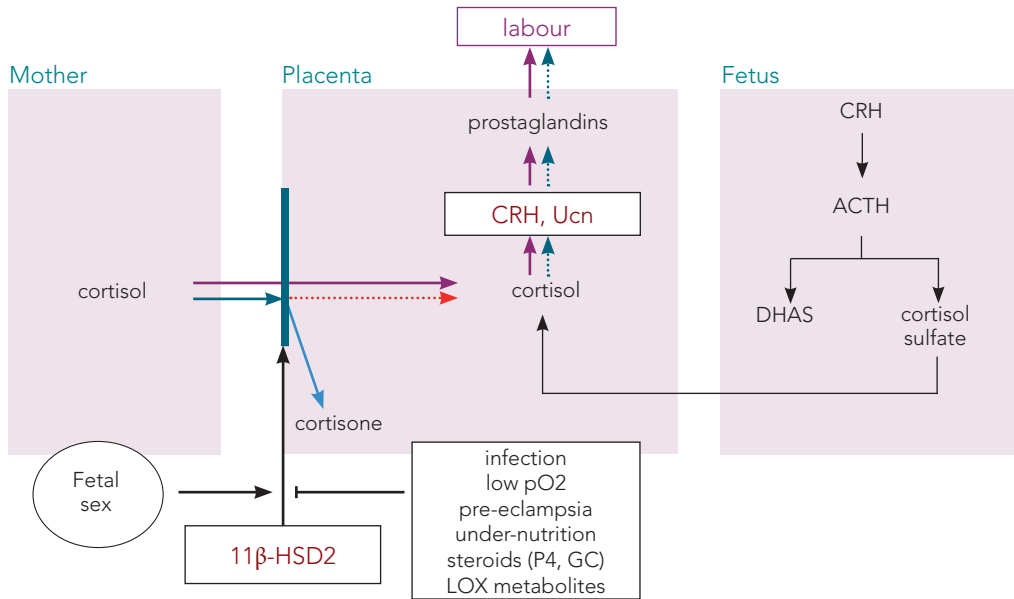

• **Figure 3.** Mean birth weight 1996-2008

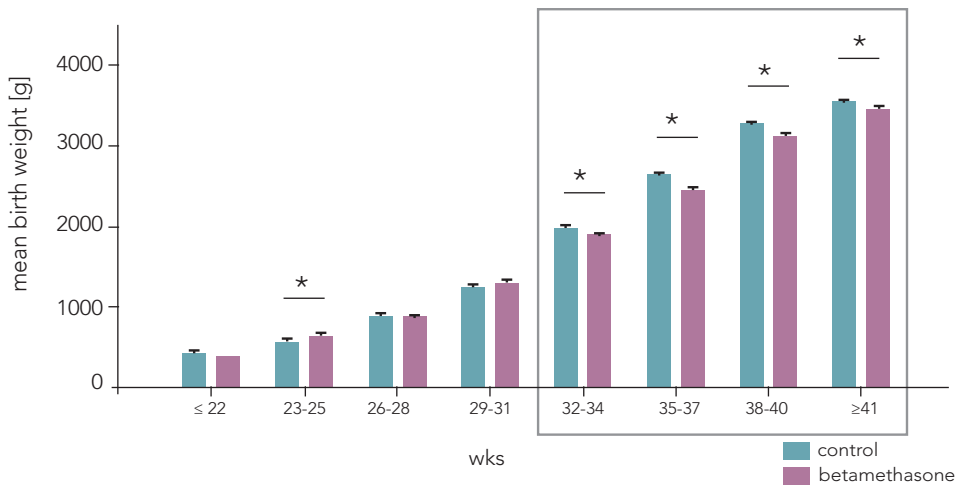

Mann Whitney U-Test, *= $p < 0.05$.

Source: Braun et al., 2015 (in press).

Estrogens produced by the placenta are pivotal in human pregnancy and parturition. Several hormones are involved in regulating estrogen production and the CRH family of peptides. (Urocortin 2 (Ucn) and CRH) has a particular role in this process by upregulating placental P450 aromatase expression and hence increasing estrogen production throughout pregnancy. These interactions may contribute crucially to the placental regulation of key reproductive events in pregnancy maintenance and parturition (• **Figures 4, 5**) [9].

With the activation of the fetal stress pathway, for example in cases of malnutrition or hypoxemia, increasing output of GC stimulates CRH and Ucn which activate CRH Receptors Type 1 or 2 (CRH-R1, CRH-R2). Then, estrogens and uterotonins are increased with consequent uterine stimulation. In parallel, these neuropeptides activate fetal membrane matrix metalloproteinase 9 (MMP-9) to promote rupture of the fetal membranes.

The relationship between CRH-related peptides, their receptors and infective pathways including chorioamnionitis and at preterm birth, has been explored by Torricelli *et al.* These observations open a new avenue of investigation about the role of these neuropeptides in pathogenetic mechanisms leading to preterm birth in which

• **Figure 4.** CRH and urocortin stimulate conversion of dehydroepiandrosterone (DHAS) into estrogen

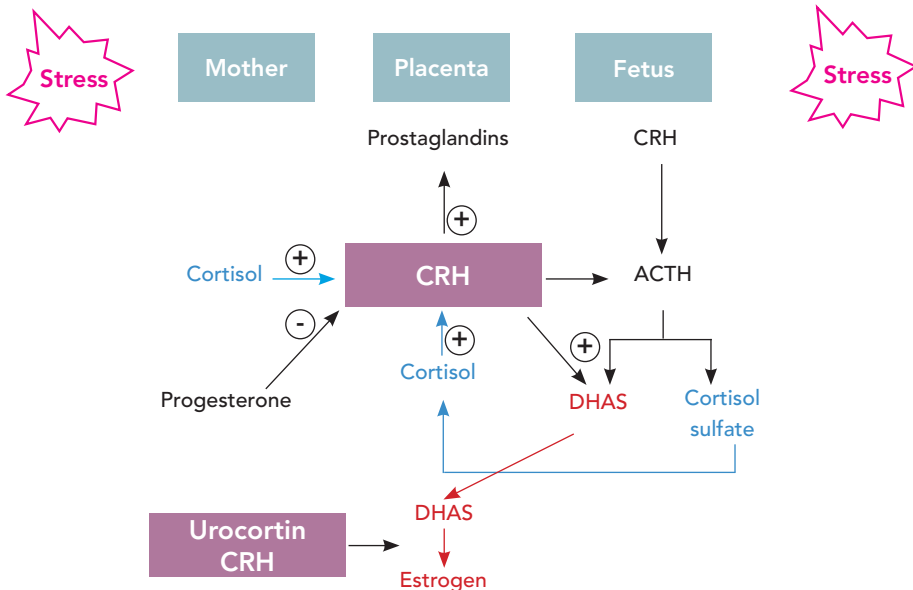

Source: Petraglia *et al.*, 2010 [10].

● **Figure 5.** CRH and Ucn effects at parturition

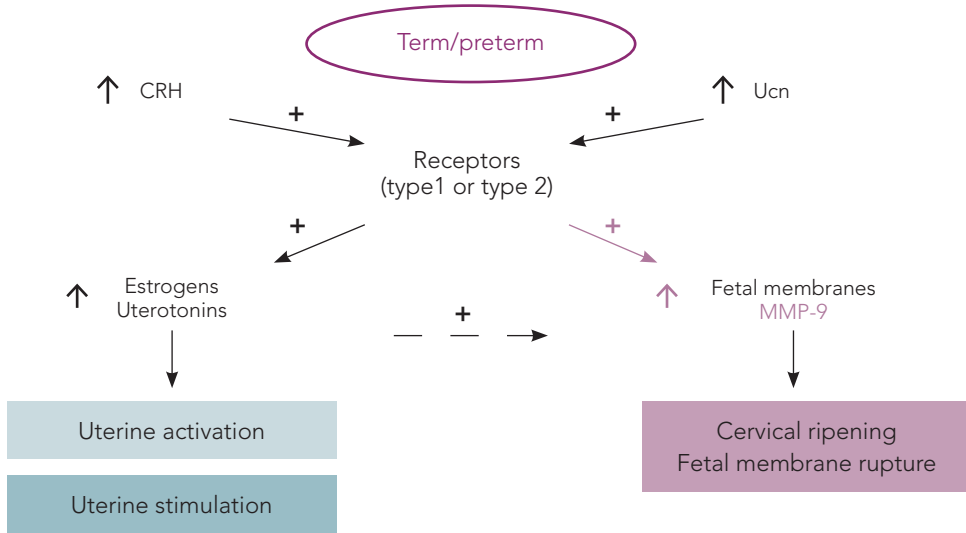

Source: Li W, Challis JRG (unpublished).

inflammatory and infective pathways represent key events. Torricelli *et al.* reproduced an infective stress by treating trophoblast cells with lipopolysaccharide (LPS) and in response to that insult, CRH, Ucn2 and CRH-R1 increased considerably, but Ucn, Ucn3 and CRH-R2 were decreased (● **Figure 6**) [11].

A similar pattern of response is seen in the placental expression of mRNA for CRH-family members in chorioamnionitis; CRH, Ucn2 and CRH-R1 mRNA expression was significantly higher in pPROM with chorioamnionitis, while Ucn, Ucn3 and CRH-R2 mRNA expression was significantly low.

These findings suggest that CRH-R1 has a pro-inflammatory activity when associated to CRH, while CRH-R2 has a double action: binding by Ucn or Ucn3 will generate an anti-inflammatory action whereas Ucn2 activates the pro-inflammatory pathway.

Yeganegi *et al.* studied the output of TNF α by human placental trophoblastic tissue stimulated with LPS and *Lactobacillus rhamnosus* GR-1 supernatant. They found that in the placenta of pregnancies that gave birth to a male, the inflammatory response was higher compared to the tissue from pregnancies with a female fetus. From these data, we can assume that perhaps males fetuses grow and develop in a more pro-inflammatory environment if compared to the female fetuses and that may contribute to the clear predominance of preterm birth in the presence of a male fetus [12]. Thus, the microbiome and relative presence of *Lactobacillus* seem to be very important in the balance of inflammation pathways and pregnancy outcomes.

In conclusion, preterm birth (PTB) has high prevalence and cost, with substantial regional, ethnic and gender differences. Understanding these differences may help understand core mechanisms of PTB. Malnutrition and hypoxemia are major stressors that upregulate fetal HPA function and result in PTB. Placental 11 β HSD-2 is a crucial mediator of placental cortisol transfer and action, PTB and fetal programming. Furthermore, in women, placental CRH affects placental and membrane endocrine function as well as MMP generation. From consideration of these points, the heterogeneous nature of PTB requires personalized (precision) approaches to diagnosis and treatment.

● **Figure 6.** Effect of LPS treatment on CRH, Ucn3 and CRH-receptor mRNA expression in term trophoblast cells

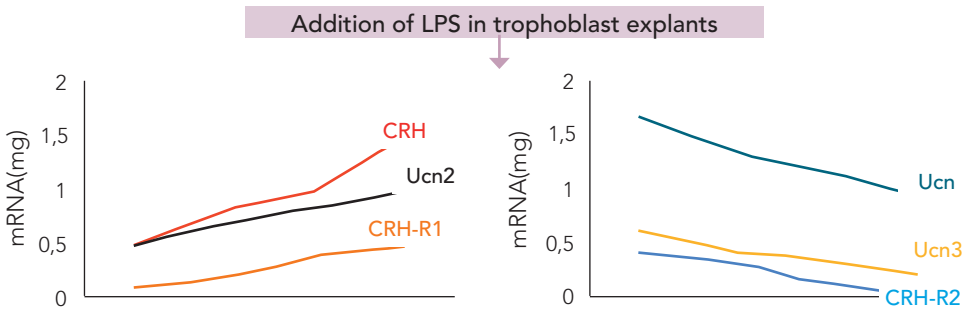

Source: Torricelli et al., 2011 [11].

References

- [1] GAPPs - Global Alliance to Prevent Prematurity and Stillbirth, 2010-15.
- [2] Challis J, Newnham J, Petraglia F, Yeganegi M, Bocking A. *Fetal sex and preterm birth*. *Placenta* 2013 Feb;34(2):95-9.
- [3] Zeitlin J, Saurel-Cubizolles MJ, De Mouzon J, Rivera L, Ancel PY, Blondel B, Kaminski M. *Fetal sex and preterm birth: are males at greater risk?* *Hum Reprod* 2002 Oct;17(10):2762-8.
- [4] Newnham JP, Sahota DS, Zhang CY, Xu B, Zheng M, Doherty DA et al. *Preterm birth rates in Chinese women in China, Hong Kong and Australia. The price of Westernisation*. *Aust N Z J Obstet Gynaecol* 2011 Oct;51(5):426-31.

- [5] Fowden AL, Li J, Forhead AJ. *Glucocorticoids and the preparation for life after birth: are there long-term consequences of the life insurance?* Proc Nutr Soc 1998 Feb;57(1):113-22.
- [6] Bloomfield FH, Oliver MH, Hawkins P, Campbell M, Phillips DJ, Gluckman PD, Challis JRG *et al.* *A periconceptual nutritional origin for noninfectious preterm birth.* Science 2003 Apr 25;300(5619):606.
- [7] Connor KL, Challis JR, van Zijl P, Rumball CW, Alix S, Jaquier AL *et al.* *Do alterations in placental 11beta-hydroxysteroid dehydrogenase (11betaHSD) activities explain differences in fetal hypothalamic-pituitary-adrenal (HPA) function following periconceptual undernutrition or twinning in sheep?* Reprod Sci 2009 Dec;16(12):1201-12.
- [8] Begum G, Stevens A, Smith EB, Connor K, Challis JR, Bloomfield F, White A. *Epigenetic changes in fetal hypothalamic energy regulating pathways are associated with maternal undernutrition and twinning.* FASEB J 2012 Apr;26(4):1694-703.
- [9] Imperatore A, Li W, Petraglia F, Challis JR. *Urocortin 2 stimulates estradiol secretion from cultured human placental cells: an effect mediated by the type 2 corticotrophin-releasing hormone (CRH) receptor.* Reprod Sci 2009 Jun;16(6):551-8.
- [10] Petraglia F, Imperatore A, Challis JR. *Neuroendocrine mechanisms in pregnancy and parturition.* Endocr Rev 2010 Dec;31(6):783-816.
- [11] Torricelli M, Novembri R, Bloise E, De Bonis M, Challis JR, Petraglia F. *Changes in placental CRH, urocortins, and CRH-receptor mRNA expression associated with preterm delivery and chorioamnionitis.* J Clin Endocrinol Metab 2011 Feb;96(2):534-40.
- [12] Yeganegi M, Watson CS, Martins A, Kim SO, Reid G, Challis JR, Bocking AD. *Effect of Lactobacillus rhamnosus GR-1 supernatant and fetal sex on lipopolysaccharide-induced cytokine and prostaglandin-regulating enzymes in human placental trophoblast cells: implications for treatment of bacterial vaginosis and prevention of preterm labor.* Am J Obstet Gynecol 2009 May;200(5):532.e1-8.

Conclusions

Stress has negative repercussions on the reproductive function. This is the clear conclusion emerging from this Forum, attended by experts from all over the world who analysed the several facets of this dangerous connection.

Take home messages are:

- chronic stress affects reproduction and independently from the stressor (psychological, metabolic, or physical) exerts a negative influence on hormonal and neuro-psychological systems in both men and women, reducing the chance to conceive;
- stress influence involves genetic and epigenetic mechanisms;
- stress is implicated in more of reproductive disorders (endometriosis, polycystic ovarian syndrome);
- important role of treatment of stress-induced anovulation, even though the target of pharmacological therapies is yet to be found;
- there are a critical relation between stress, implantation, early pregnancy and artificial reproductive therapy;
- stress remains a potentially dangerous condition during pregnancy, causing abortion and leading to preterm birth.



The international Forum “Stress, inflammation, and reproduction”, organized by IBSA Foundation for scientific research and hosted at the University of Siena on July 3, 2015, has been dedicated to the life and science of the eminent endocrinologist Wylie Vale.

The main message emerging from the Forum is that stress has important negative repercussions on the reproductive function. In the magnificent University Great Hall, crowded by many students, experts from all over the world analysed the several aspects of this dangerous connection and the possible therapies to promote women’s health before and during pregnancy.